

2022

**KESİCİ UÇ KATALOĞU**  
**INSERT CATALOGUE**  
**WENDESCHNEIDPLATTE KATALOG**



 **AKKO**<sup>®</sup>

Kesici Uç ve Bağlama Sistemleri  
*Cutting Inserts and Connection Systems*  
*Trägerwerkzeuge für Wendschneidplatten*

 [www.akkо.com.tr](http://www.akkо.com.tr)

    AKKO Metalworking Tools

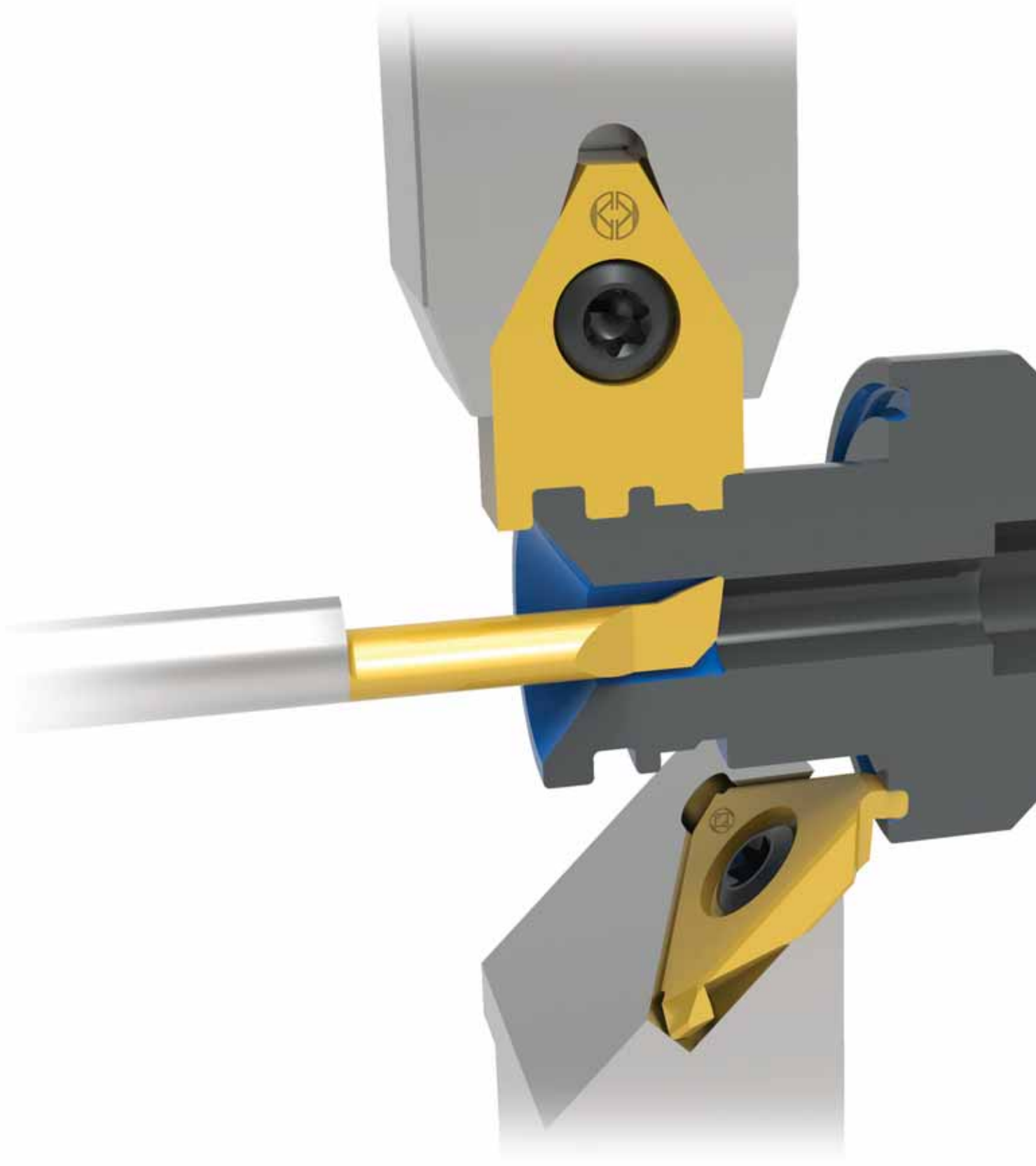

1986 yılında Abdullah KARAKUŞ tarafından kurulan AKKO Makina Sanayi ve Ticaret A.Ş. Tornalama Takımları, Diş ve Kanal Açma Takımları, Delik Delme Takımları, Frezeleme Takımları ve talebe yönelik Özel Takımları üretmektedir. Şu an 39.000 m<sup>2</sup>' ye yakın bir alanda Türkiye, Japonya, Almanya, İsviçre gibi ülkelerin ürettikleri son teknoloji tezgah ve ekipmanlarıyla yıllık 400.000 adet üretim kapasitesiyle, standart 10.000 çeşit takım üretimi yapmaktadır. Avrupa, Asya, Afrika, Güney Amerika, Kuzey Amerika ve Orta Doğu kıtalarında şimdilik 90 ülkeye ürün sevkiyatına devam etmektedir. Minimum 300.000 adet üretilmiş ürün stoklarında mevcut bulunmaktadır. Firma için özel üretilen çelik hammadde işleme girer ve bütün üretim süreci kendi bünyesinde gerçekleşmektedir. Çeliğin işlenmesi, ısıt işlemleri, üzerindeki kaplama ve her türlü üretim operasyonları bir entegre tesis olan AKKO'da yapılmaktadır.

We as AKKO Makina Sanayi ve Ticaret A.Ş. which has been founded by Abdullah KARAKUŞ in 1986, produces Turning Tool Holders, Threading and Grooving Tool Holders, U-Drills, Milling Tool Holders, and Precision Tool Holders ( OEM Tool Holders ) on-demand. We produce standard 10.000 kinds of tool holders with a production capacity of 400.000 pieces per annum in an area of about 39.000 square meters. We are going on exporting to 90 countries including European, Asian, African, South American Countries, North American Countries, and Middle East Countries. We keep ready about 300.000 pieces produced products in our stock. Steel Raw materials that we make produced especially for us are delivered our factory and all production process are made in our factory. All kinds of operations from machining of steel to heat treatment and coating on our tools are made in our integrated factory AKKO.

Wir die Firma AKKO Makina Sanayi ve Ticaret A.Ş. welches durch Herrn Abdullah Karakuş in 1986 gegründet wurde, produzieren Dreh-, Gewinde- und Stechwerkzeuge für Wendeschneidplatten. Ebenso gehören Wendeplattenbohrer, Wendeplattenfräser und Sonderwerkzeuge nach Anfrage für Wendeplatten zum Lieferprogramm. Alle Werkzeuge sind auch als OEM-Version lieferbar. Wir produzieren 10.000 standart Arten der Werkzeughalter mit einer Produktionskapazität von 400.000 Stücken per annum auf einer Fläche von 39.000 quadrat meter. Wir exportieren unsere eigenproduzierten Ware nach 90 Ländern, Europa, Asien, Afrika, Süd amerikanische Länder, Mittlerer Osten. Lieferbereit halten wir 300.000 Stück produzierte Produkte auf Lager. Das eingesetzte Rohmaterial wird speziell für unsere Firma produziert. Alle Produktionsschritte werden auf unseren eigenen Anlagen veranlasst. Alle einzelnen Produktionsschritte wie z.B. mechanische Bearbeitung, Wärmebehandlung und Beschichtung unserer Werkzeuge erfolgen auf unseren eigenen Maschinenanlagen.

S8-S11  
S8-S11  
S8-S11

**POLY-V KAYIS KASNAK KANAL AÇMA UÇLARI VE TAKIMLARI**  
TEK KANALLI POLY-V UÇLARI VE TAKIMLARI  
ÇİFT KANALLI POLY-V UÇLARI VE TAKIMLARI  
ÇOK KANALLI POLY-V UÇLARI VE TAKIMLARI

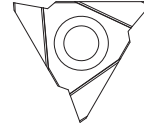

S12-S15  
S12-S15  
S12-S15

**KANAL AÇMA, YÜZEY KANAL AÇMA UÇLARI VE TAKIMLARI**  
YÜZEY KANAL AÇMA UÇLARI VE TAKIMLARI  
RADYUSLU KÖŞE BOŞALTMA UÇLARI VE TAKIMLARI  
ÖZEL KANAL UCU BİLGİ ALMA FORMU

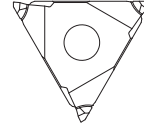

S16-S19  
S16-S19  
S16-S19  
S16-S19  
S16-S19  
S16-S19

**BROŞ ÇEKME (KAMA) UÇLARI VE TAKIMLARI**  
BROŞ ÇEKME TAKIMLARI  
BROŞ ÇEKME (KAMA) UÇLARI (DIN138) (C11 TOLERANS)  
BROŞ (KAMA) UÇLARI (DIN6885) (P9 TOLERANS)  
KAMA KANALI PAH KIRMA UÇLARI  
ÖZEL PROFİL BROŞ UCU BİLGİ ALMA FORMU

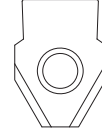

S26-S29  
S26-S29  
S26-S29  
S26-S29  
S26-S29  
S26-S29

**WHIRLING UÇLARI VE TAKIMLARI**  
WHIRLING TAKIMLARI (RING)  
WHIRLING UÇLAR (ISO 5835)  
WHIRLING UÇLAR (ISO 9268)  
WHIRLING UÇLAR (ISO 9268)  
WHIRLING UÇLAR (METRİK DIN 13)  
WHIRLING UÇLAR BİLGİ ALMA FORMU

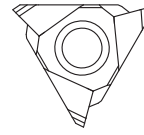

S31  
S32-S40  
S41  
S42  
S43

**MINİ CUT TAKIMLAR**  
DELİK İÇİ MINİ CUT TAKIMLAR  
KANAL AÇMA MINİ CUT TAKIMLAR  
DİŞ ÇEKME MINİ CUT TAKIMLAR  
ALIN KANALI AÇMA TAKIMLARI  
ÖZEL PROFİL MINİ CUT TAKIMLAR BİLGİ ALMA FORMU



S45  
S46  
S47  
S47

**TORX – ALYAN / PUNCH - KAZIMA TAKIMLARI**  
TORX PUNCH TAKIMLARI  
ALYAN PUNCH TAKIMLARI  
TORX KAZIMA TAKIMLARI  
ALYAN KAZIMA TAKIMLARI

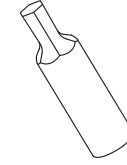

S48

**S-DRİLL TAKMA UÇLU MATKAP TAKIMLARI VE UÇLARI**  
S-DRILL UÇLAR

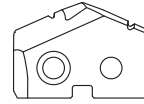

S50-S51  
S52  
S53

**DİŞ AÇMA FREZELEME TAKIMLARI VE UÇLARI**  
DİŞ AÇMA FREZELEME TAKIMLARI  
C14-C21 DİŞ TARAĞI UÇLARI  
DİŞ UCU ÖZEL PROFİL BİLGİ ALMA FORMU

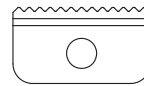

S55  
S56  
S57

**SEGMAN UÇLARI VE TAKIMLARI**  
SEGMAN TAKIMLARI  
SEGMAN UÇLARI (DIN471)  
ÖZEL PROFİL SEGMAN UÇLARI BİLGİ ALMA FORMU

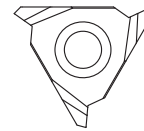

#### ÖZEL ÇÖZÜMLER

S67-S68  
S68-S70  
S70  
S71

**SUPAP YUVASI İŞLEME UÇLARI VE TAKIMLARI**  
SUPAP YUVASI İŞLEME TAKIMLARI  
SUPAP YUVASI İŞLEME UÇLARI  
SUPAP YUVASI İŞLEME ÖZEL UÇ BİLGİ ALMA FORMU  
PILOT MİLLER



S72-S91  
S92-S99  
S100-S102

**ISO UÇLAR**  
WCMX/SPMX UÇLAR  
KESME VE KANAL AÇMA UÇLARI  
AYARLANABİLİR BAĞA UÇLARI



# İÇİNDEKİLER

# CONTENTS

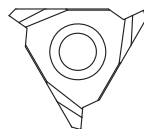
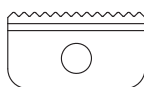
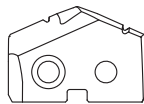
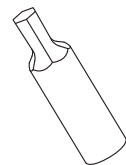
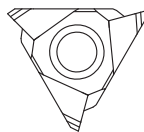
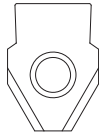
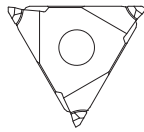
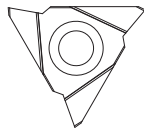

## POLY-V BELT PULLEY GROOVING INSERTS AND TOOLHOLDERS

INSERTS FOR GROOVING SINGLE V-RIBBED PULLEYS  
INSERTS FOR GROOVING DOUBLE V-RIBBED PULLEYS  
INSERTS FOR GROOVING MULTI V-RIBBED PULLEYS

P8-P11  
P8-P11  
P8-P11

## GROOVING, FACE GROOVING INSERTS AND TOOLHOLDERS

FACE GROOVING INSERTS AND TOOLHOLDERS  
INSERTS AND TOOLHOLDERS FOR GROOVING CORNER RELIEFS WITH RADIUS  
INFORMATION FORM FOR SPECIAL GROOVING INSERTS

P12-P15  
P12-P15  
P12-P15

## BROACHING (KEYWAY) INSERTS AND TOOLHOLDERS

BROACHING TOOLHOLDERS  
BROACHING (KEYWAY) INSERTS (DIN138) (TOLERANCE C11)  
BROACHING (KEYWAY) INSERTS (DIN6885) (TOLERANCE P9)  
INSERTS FOR KEYWAY CHAMFERING  
INFORMATION FORM FOR SPECIAL PROFILE BROACHING INSERTS

P16-P19  
P16-P19  
P16-P19  
P16-P19  
P16-P19

## WHIRLING INSERTS AND TOOLHOLDERS

WHIRLING TOOLHOLDERS (RING)  
WHIRLING INSERTS (ISO 5835)  
WHIRLING INSERTS (ISO 9268)  
WHIRLING INSERTS (ISO 9268)  
WHIRLING INSERTS (METRIC DIN 13)  
INFORMATION FORM FOR WHIRLING INSERTS

P26-P29  
P26-P29  
P26-P29  
P26-P29  
P26-P29  
P26-P29

## MINI CUT TOOLS

INTERNAL MINI CUT TOOLS  
GROOVING MINI CUT TOOLS  
THREADING MINI CUT TOOLS  
MINI CUT FACE GROOVING TOOLS  
INFORMATION FORM FOR SPECIAL PROFILE MINI CUT TOOLS

P31  
P32-P40  
P41  
P42  
P43

## TORX - ALLEN / PUNCH - BROACH SET

TORX PUNCH  
ALLEN PUNCH  
TORX BROACH  
ALLEN BROACH

P45  
P46  
P47  
P47

## INDEXABLE S-DRILLS AND INSERTS

INDEXABLE S-DRILL INSERTS

P48

## THREAD MILLING TOOLHOLDERS AND INSERTS

THREAD MILLING TOOLHOLDERS AND INSERTS  
C14-C21 THREAD PITCH GAUGE INSERTS  
INFORMATION FORM FORE SPECIAL PROFILE THREADING INSERT

P50-P51  
P52  
P53

## RING INSERTS AND TOOLHOLDERS

RING TOOLHOLDERS  
RING INSERTS (DIN471)  
SPECIAL PROFILE RING INSERTS INFORMATION FORM

P55  
P56  
P57

## SPECIAL SOLUTIONS

### VALVE SEAT INSERTS AND TOOLHOLDERS

VALVE SEAT TOOLHOLDERS  
VALVE SEAT INSERTS  
INFORMATION FORM FOR VALVE SEAT INSERTS  
CARBIDE PILOT FOR VALVE SEAT

P67-P68  
P68-P70  
P70  
P71

### ISO INSERTS

WCMX-SPMX INSERTS  
GROOVING & PARTING INSERT  
ADJUSTABLE BORING INSERT

P72-P91  
P92-P99  
P100-P102

**WENDESCHNEIDPLATTEN UND WERKZEUGE FÜR POLY-V RIEMENSCHLEIBEN**  
 P8-P11 WENDESCHNEIDPLATTEN UND WERKZEUGE ZUM NUTEN VON KEILRIPPENSCHLEIBEN  
 P8-P11 WENDESCHNEIDPLATTEN UND WERKZEUGE ZUM NUTEN VON DUAL KEILRIPPENSCHLEIBEN  
 P8-P11 WENDESCHNEIDPLATTEN UND WERKZEUGE ZUM NUTEN VON MULTI KEILRIPPENSCHLEIBEN

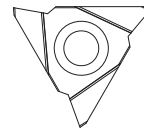

**WENDESCHNEIDPLATTEN UND WERKZEUGE FÜR NUTEN UND OBERFLÄCHENNUTEN**  
 P12-P15 WENDESCHNEIDPLATTEN UND WERKZEUGE FÜR OBERFLÄCHENNUTEN  
 P12-P15 WENDESCHNEIDPLATTEN UND WERKZEUGE FÜR AXIAL FREISTICHE  
 P12-P15 INFORMATIONSFOM FÜR SONDER WENDESCHNEIDPLATTEN

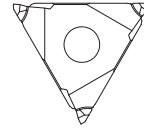

**WENDESCHNEIDPLATTEN UND WERKZEUGHALTER FÜR DIE NUTBEARBEITUNG**  
 P16-P19 WERKZEUGHALTER FÜR DIE NUTBEARBEITUNG  
 P16-P19 WENDESCHNEIDPLATTEN FÜR DIE NUTBEARBEITUNG  
 P16-P19 WENDESCHNEIDPLATTEN FÜR DIE NUTBEARBEITUNG (DIN6885) (P9 TOLERANZ)  
 P16-P19 WENDESCHNEIDPLATTEN FÜR KEILNUTTUNGSBEARBEITUNGEN  
 P16-P19 INFORMATIONSFOMULAR FÜR SONDER WENDESCHNEIDPLATTEN ZURNUTTUNGSBEARBEITUNGEN

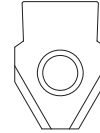

**WENDESCHNEIDPLATTEN UND WERKZEUGHALTER ZUM GEWINDEWIRBELN**  
 P26-P29 GEWINDEWIRBEL (RING)  
 P26-P29 GEWINDEWIRBEL FÜR (ISO 5835)  
 P26-P29 GEWINDEWIRBEL FÜR (ISO 9268)  
 P26-P29 GEWINDEWIRBEL FÜR (ISO 9268)  
 P26-P29 GEWINDEWIRBEL FÜR (METRIK DIN 13)  
 P26-P29 INFORMATIONSFROM FÜR GEWINDEWIRBEL

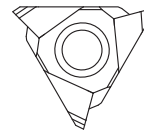

**MINI CUT WERKZEUGE**  
 P31 MINI CUT WERKZEUGE FÜR INNENBOHRUNG  
 P32-P40 MINI CUT WERKZEUGE FÜR NUTEN  
 P41 GEWINDE MINI CUT WERKZEUGE  
 P42 WENDESCHNEIDPLATTEN  
 P43 INFORMATIONSFOM FÜR SONDERPROFIL MINI CUT WERKZEUGE



**WINKELSCHRAUBENDREHER / EINSATZRING SET**  
 P45 TORX STANZWERKZEUGE  
 P46 WINKELSCHRAUBENDREHER WERKZEUGE  
 P47 SCHRAUBENRING  
 P47 WINKELSCHRAUBENDREHERRING

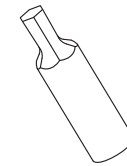

**S-SYSTEM VOLLBOHRER/BEZEICHNUNGSSYSTEM FÜR VOLLBOHRER**  
 P48 S-SYSTEM BOHRSPITZEN

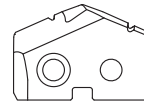

**GEWINDEFÄSSERWERKZEUGE**  
 P50-P51 GEWINDEFÄSSERWERKZEUGE  
 P52 WENDESCHNEIDPLATTEN FÜR C14-C21 GEWINDESTAIGUNG  
 P53 INFORMATIONSFOMULAR FÜR SONDER GEWINDEPLATTEN

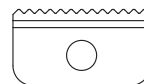

**RINGPLATTEN UND WERKZEUGE**  
 P55 RINGPLATTEN WERKZEUGE  
 P56 RINGPLATTEN (DIN471)  
 P57 INFORMATIONSFOM FÜR SONDERRINGPLATTEN

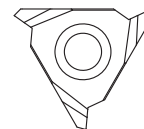

## SONDERLÖSUNGEN

**WENDESCHNEIDPLATTEN UND WERKZEUGE FÜR VENTILSITZE**  
 P67-P68 WENDESCHNEIDPLATTEN FÜR VENTILSITZE  
 P68-P70 BOHRUNGSSPITZEN FÜR VENTILSITZ BEARBEITUNG  
 P70 INFORMATIONSFOM FÜR SONDER VENTILSITZ BEARBEITUNG  
 P71 METALLSCHAFT FÜR VENTILSITZ



**ISO WENDESCHNEIDPLATTE**  
 P72-P91 WCMX-SPMX WENDESCHNEIDPLATTE  
 P92-P99 AUSSTECH UND EINSTECHWENDESCHNEIDPLATTEN  
 P100-P102 EINSTELLBARE WENDESCHNEIDPLATTEN FÜR SPINDELKÖPFE





**konusulan** kalite...  
**the spoken** quality...  
qualitt ber die man spricht...

# POLY-V

**KAYIŞ KASNAK KANAL AÇMA UÇLARI VE TAKIMLARI**

*POLY-V BELT PULLEY GROOVING INSERTS AND TOOLHOLDERS*  
*WENDESCHNEIDPLATTEN UND WERKZEUGE FÜR*  
*POLY-V RIEMENSCHLEIBEN*





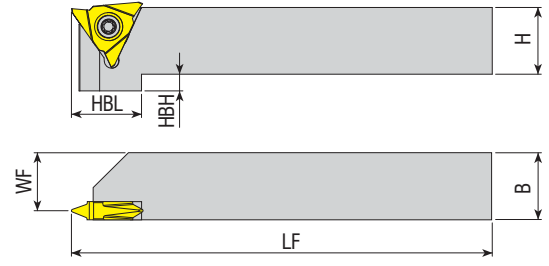

Takım Kodu Ordering Code Bestell-Bezeichnung	Stok Stock Lager		Takım Ölçüleri (mm) Dimension (mm) Abmessung (mm)					Kesici Uç Insert Wendeschneidplatte	Yedek Parçaları / Spare Parts / Ersatzteile		
	R	L	H	B	WF	LF	HBL	HBH	Sıkma Vidası Screw Schraube	Tork Anahtar Torx Key Torx-Schlüssel	
ADKT-T12P-R/L-1616-T5	●	●	16	16	13.50	125	21	5			
ADKT-T12P-R/L-2020-T5	●	●	20	20	17.50	125	21	5	T12...	1020-M5x14	80-T20
ADKT-T12P-R/L-2525-T5	●	●	25	25	22.50	150	-	-			
ADKT-T12P-R/L-3232-T5	●	●	32	32	29.50	170	-	-			

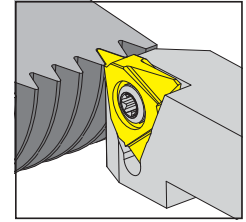
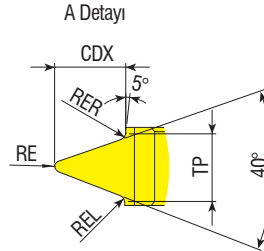
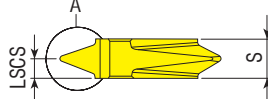
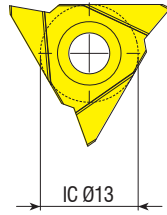
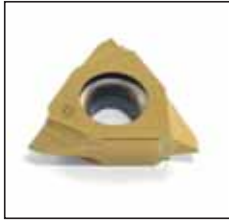

Uç Kodu Insert Code Wendeplatten-Bezeichnung	Stok Stock Lager		Uç Ölçüleri (mm) Insert Dimension (mm) Abmessung (mm)							Kalite Grade Sorte
	R	L	DIN/ISO KODU	TP	S	RE	RER / REL	LSCS	CDX	
T12.10.0234.PJ.R/L	●	●	PJ	2.34	5.20	0.36	0.24	2.60	2.08	VK20F01
T12.10.0356.PK.R/L	●	●	PK	3.56	5.20	0.44	0.35	2.60	3.40	VK20F01
T12.10.0470.PL.R/L	●	●	PL	4.70	5.20	0.36	0.45	2.60	4.90	VK20F01

R: Sağ / Right / Rechts L: Sol / Left / Links

● Stokta / In Stock / Auf Lager ○ Stokta Yok / Non Stock Item / Kein Lagerartikel, Lieferzeit auf Anfrage

ADKT-T12P... Tipi kateerler ile kullanınız. / Use with ADKT-T12P... Type toolholder. / Einsatz mit ADKT-T12P...-Werkzeughalter

İndekslenişinde boy  $\pm 0,02$ mm / Indexability length  $\pm 0,02$ mm / Wiederholgenauigkeit Länge  $\pm 0,02$  mm

Diğer ölçü talepleriniz için müşteri temsilciniz ile irtibata geçiniz. / For other dimension request, contact with customer representative. / Für weitere Abmessungen kontaktieren Sie bitte den Vertrieb.

Sipariş Örneği/Ordering Example/Bestellbeispiel

1 ad./pcs./stück ADKT-T12P-R-1616-T5

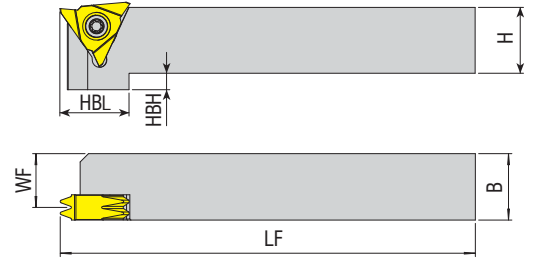

Takım Kodu Ordering Code Bestell-Bezeichnung	Stok Stock Lager		Takım Ölçüleri (mm) Dimension (mm) Abmessung (mm)					Kesici Uç Insert Wendeschneidplatte	Yedek Parçaları / Spare Parts / Ersatzteile		
	R	L	H	B	WF	LF	HBL		HBH	Sıkma Vidası Screw Schraube	Tork Anahtar Torx Key Torx-Schlüssel
ADKT-T30P-R-1616-3.56	●	●	16	16	12.2	125	20	5	T30...	1020x M5 X14	80-T20
ADKT-T30P-R-1616-2.34	●	●	16	16	12.2	125	20	5			
ADKT-T30P-R-2020-3.56	●	●	20	20	16.2	125	20	3			
ADKT-T30P-R-2020-2.34	●	●	20	20	16.2	125	20	3			
ADKT-T30P-R-2525-3.56	●	●	25	25	21.2	150	-	-			
ADKT-T30P-R-2525-2.34	●	●	25	25	21.2	150	-	-			
ADKT-T30P-R-3232-3.56	●	●	32	32	28.2	170	-	-			
ADKT-T30P-R-3232-2.34	●	●	32	32	28.2	170	-	-			

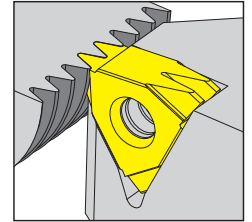
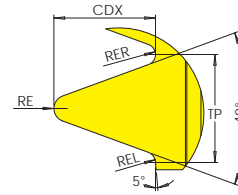
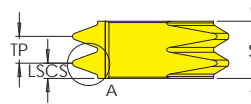
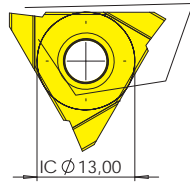

Uç Kodu Insert Code Wendepplatten-Bezeichnung	Stok Stock Lager	Uç Ölçüleri (mm) Insert Dimension (mm) Abmessung (mm)						Kalite Grade Sorte
		DIN/ISO KODU	TP	S	RER/RE	LSCS	CDX	
T30.07.0234.PJ.x2	●	PJ	2.34	7.60	0.24	2.60	2.08	VK20F01
T30.07.0356.PK.x2	●	PK	3.56	7.60	0.35	2.60	3.40	VK20F01

R: Sağ / Right / Rechts L: Sol / Left / Links

● Stokta / In Stock / Auf Lager ○ Stokta Yok / Non Stock Item / Kein Lagerartikel, Lieferzeit auf Anfrage

Sipariş Örneği/Ordering Example/Bestellbeispiel

1 ad./pcs./stück ADKT-T30P-R-1616-3.56

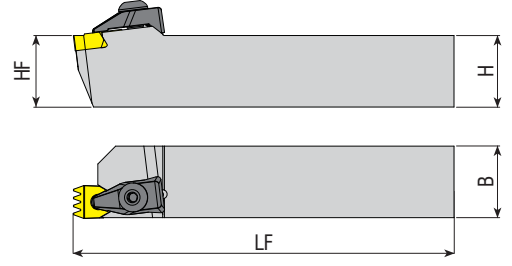

Takım Kodu Ordering Code Bestell-Bezeichnung	Stok Stock Lager		Takım Ölçüleri (mm) Dimension (mm) Abmessung (mm)			Kesici Uç Insert Wendeschneidplatte	Baskı Pabucu Wedge Clamp Spannpratze	Yedek Parçaları / Spare Parts / Ersatzteile		
	R	L	HF=H	B	LF			Pabuç Vidası Clamp Screw Schraube	Anahtar Allen Key Innensechskantschlüssel	
ATPVK 2020 K2.34X4	○	○	20	20	125	B26.07.0234PJ.x4	ATK-04	AKV-19-M7X25	AAL-05-4	
ATPVK 2525 M2.34X4	○	○	25	25	150					
ATPVK 3232 P2.34X4	●	○	32	32	170					
ATPVK 2020 K3.56X4	○	○	20	20	125	B26.07.0356PK.x4	ATK-04	AKV-19-M7X25	AAL-05-4	
ATPVK 2525 M3.56X4	○	○	25	25	150					
ATPVK 3232 P3.56X4	●	○	32	32	170					
ATPVK 2020 K4.7X3	○	○	20	20	125	B26.07.0470PL.x3	ATK-04	AKV-19-M7X25	AAL-05-4	
ATPVK 2525 M4.7X3	○	○	25	25	150					
ATPVK 3232 P4.7X3	●	○	32	32	170					

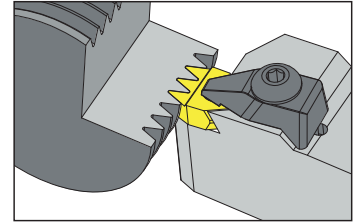
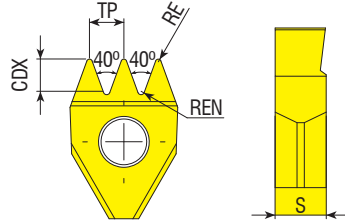

Uç Kodu Insert Code Wendepplatten-Bezeichnung	Stok Stock Lager	Uç Ölçüleri (mm) Insert Dimension (mm) Abmessung (mm)						Kalite Grade Sorte
		DIN/ISO KODU	TP	S	RE	REN	CDX	
B26.07.0234.PJx4	●	PJ	2.34	7	0.36	0.24	2.05	VK10F01
<b>new</b> B26.07.0356.PKx3	●	PK	3.56	7	0.45	0.35	3.35	VK10F01
B26.07.0356.PKx4	●	PK	3.56	7	0.45	0.35	3.35	VK10F01
B26.07.0470.PLx3	●	PL	4.70	7	0.38	0.45	4.85	VK10F01

R: Sağ / Right / Rechts L: Sol / Left / Links

● Stokta / In Stock / Auf Lager ○ Stokta Yok / Non Stock Item / Kein Lagerartikel, Lieferzeit auf Anfrage

Sipariş Örneği/Ordering Example/Bestellbeispiel

1 ad./pcs./stück ATPVK 2020 K2.34X4

# KANAL AÇMA

**KANAL AÇMA, KÖŞE BOŞALTIMA UÇLARI ve TAKIMLARI**  
*INSERTS and TOOLHOLDERS FOR GROOVING CORNER RELIEFS*  
*WENDESCHNEIDPLATTEN UND WERKZEUGE FÜR*  
*AXIAL FREISTICHE*

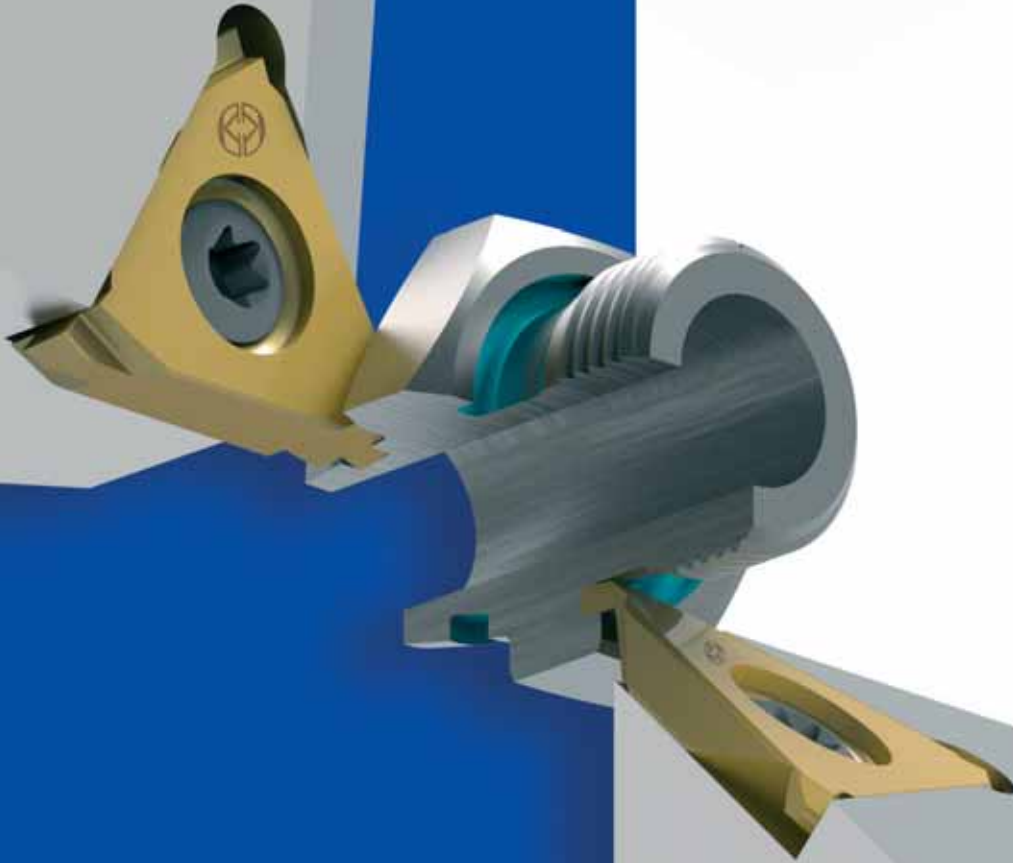

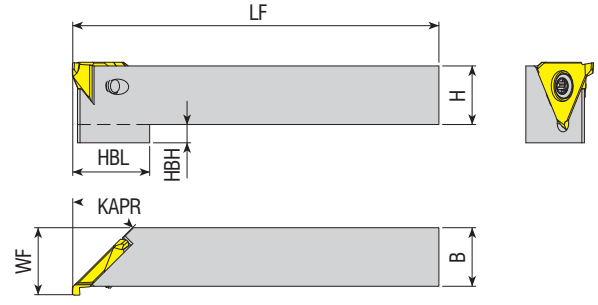

Takım Kodu Ordering Code Bestell-Bezeichnung	Stok Stock Lager		Takım Ölçüleri (mm) Dimension (mm) Abmessung (mm)						Kesici Uç Insert Wendeschneidplatte	Yedek Parçaları / Spare Parts / Ersatzteile		
	R	L	H	B	WF	LF	HBL	HBH		KAPR	Sıkma Vidası Screw Schraube	Tork Anahtar Torx Key Torx-Schlüssel
AAUT-T20-R/L-1616-45	●	●	16	16	18.3	125	21	5	45°	T20...	1020-M5x7.5	80-T20
AAUT-T20-R/L-2020-45	●	●	20	20	22.3	125	21	5	45°			
AAUT-T20-R/L-2525-45	●	●	25	25	27.3	150	-	-	45°			

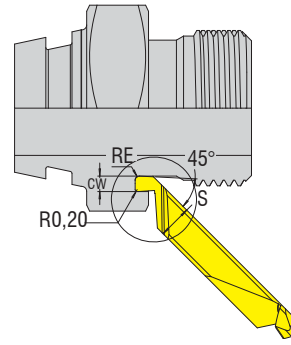
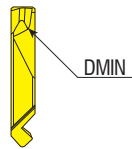
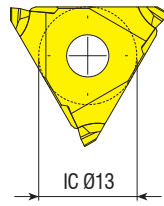

Sağ versiyon gösterilmiştir  
 Right hand version shown  
 Abbildung zeigt rechte Ausführung

Uç Kodu Insert Code Wendeplatten-Bezeichnung	Stok Stock Lager		Uç Ölçüleri (mm) Insert Dimension (mm) Abmessung (mm)				Kalite Grade Sorte	Minimum Çap Ø Minimum Diameter Ø Kleinster Durchmesser ø	Kanal Derinliği Depth of Groove Up to Stechtiefe bis zu	Kanal Genişliği Width of Groove Stechbreite	
	R	L	CW	S	RE	CDX					DMIN
T20.00.0815.45.04R/L	●	●	1.5	3.25	0.4	1.6	8	VK20F01	8	1.6	1.5
T20.00.1220.45.05R/L	●	●	2.0	3.25	0.5	1.8	12	VK20F01	12	1.8	2.0
T20.00.2024.45.06R/L	●	●	2.4	3.25	0.6	2.0	20	VK20F01	20	2.0	2.4

AAUT.. Tipi katerlerle kullanınız. / Use with AAUT type toolholder. / Einsatz mit AAUT-Werkzeughalter

Kullanım öncesinde dip boşluk işlenmiş olmalıdır. / The undercut must be placed before axial machining. / Der Freistich muss vor der Axialbearbeitung gefertigt werden

İndekslenliğinde boy ±0.02mm / Indexability length ±0.02mm / Wiederholgenauigkeit Länge ± 0,02 mm

Sipariş Örneği/Ordering Example/ Bestellbeispiel  
 1 ad./pcs./stück AAUT-T20-R/L-1616-45

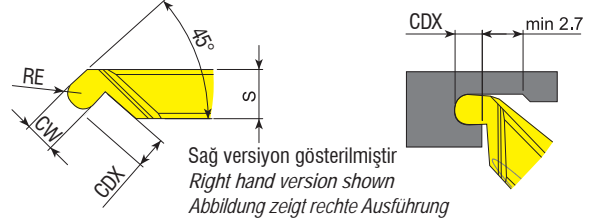
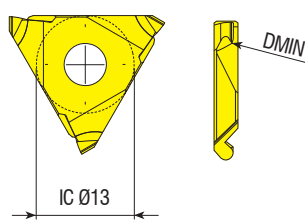

**Uç Kodu**  
**Insert Code**  
 Wendeplatten-Bezeichnung

Stok  
 Stock  
 Lager

Uç Ölçüleri (mm)  
 Insert Dimension (mm)  
 Abmessung (mm)

Kalite  
 Grade  
 Sınıf

Minimum Çap Ø  
 Minimum Diameter Ø  
 Kleinster Durchmesser ø

Kanal Derinliği  
 Depth of Groove Up to  
 Stechtiefe bis zu

Kanal Genişliği  
 Width of Groove  
 Stechbreite

T20.00.1220.45.10R/L

● ●

2.0

3.25

1.0

1.8

12

VK20F01

12

1.8

2

AAUT.. Tipi katerlerle kullanınız. / Use with AAUT type toolholder. / Einsatz mit AAUT-Werkzeughalter  
 Kullanım öncesinde dip boşluk işlenmiş olmalıdır. / The undercut must be placed before axial machining. / Der Freistich muss vor der Axialbearbeitung gefertigt werden  
 İndekslenişinde boy ±0.02mm / Indexability length ±0.02mm / Wiederholgenauigkeit Länge ± 0,02 mm

R: Sağ / Right / Rechts L: Sol / Left / Links

● Stokta / In Stock / Auf Lager ○ Stokta Yok / Non Stock Item / Kein Lagerartikel, Lieferzeit auf Anfrage

Sipariş Örneği/Ordering Example/Bestellbeispiel  
 1 ad./pcs./stück T20.00.1220.45.10R/L

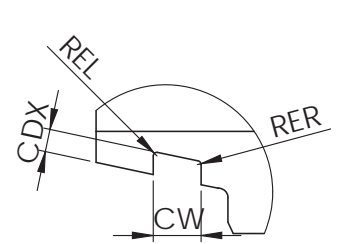
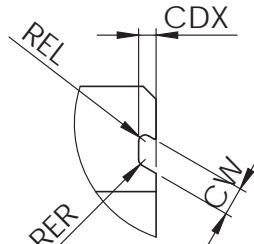
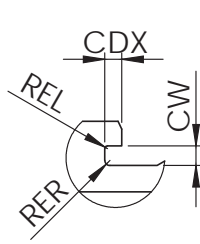
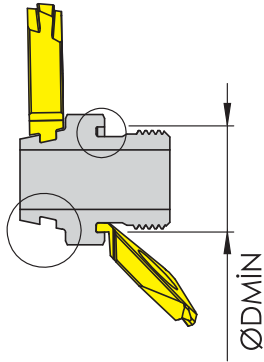

**ÖZEL KANAL UCU BİLGİ ALMA FORMU**  
**INFORMATION FORM FOR SPECIAL GROOVING INSERTS**  
**INFORMATIONFORM FÜR SONDER WENDESCHNEIDPLATTEN**

CW	CDX	RER	REL	DMIN	İŞPARÇASI MALZEMESİ / WORKPIECE MATERIAL/ WERKSTÜCKMATERIAL

Farklı özel profilleri için lütfen irtibata geçiniz. / Please contact for different special profiles. / Bitte kontaktieren Sie uns für Sonderwendschneidplatten

vav@vavkesici.com.tr adresine teknik resim göndermeniz halinde iş parçanıza özel tasarımlar yapılabilir. / If you send a technical drawing to vav@vavkesici.com.tr special designs can be made for your workpiece. / Bei Einreichung von der technischne Zeichnung an vav@vavkesici.com.tr können auch Werkzeug spezifische Entwürfe hergestellt werden.

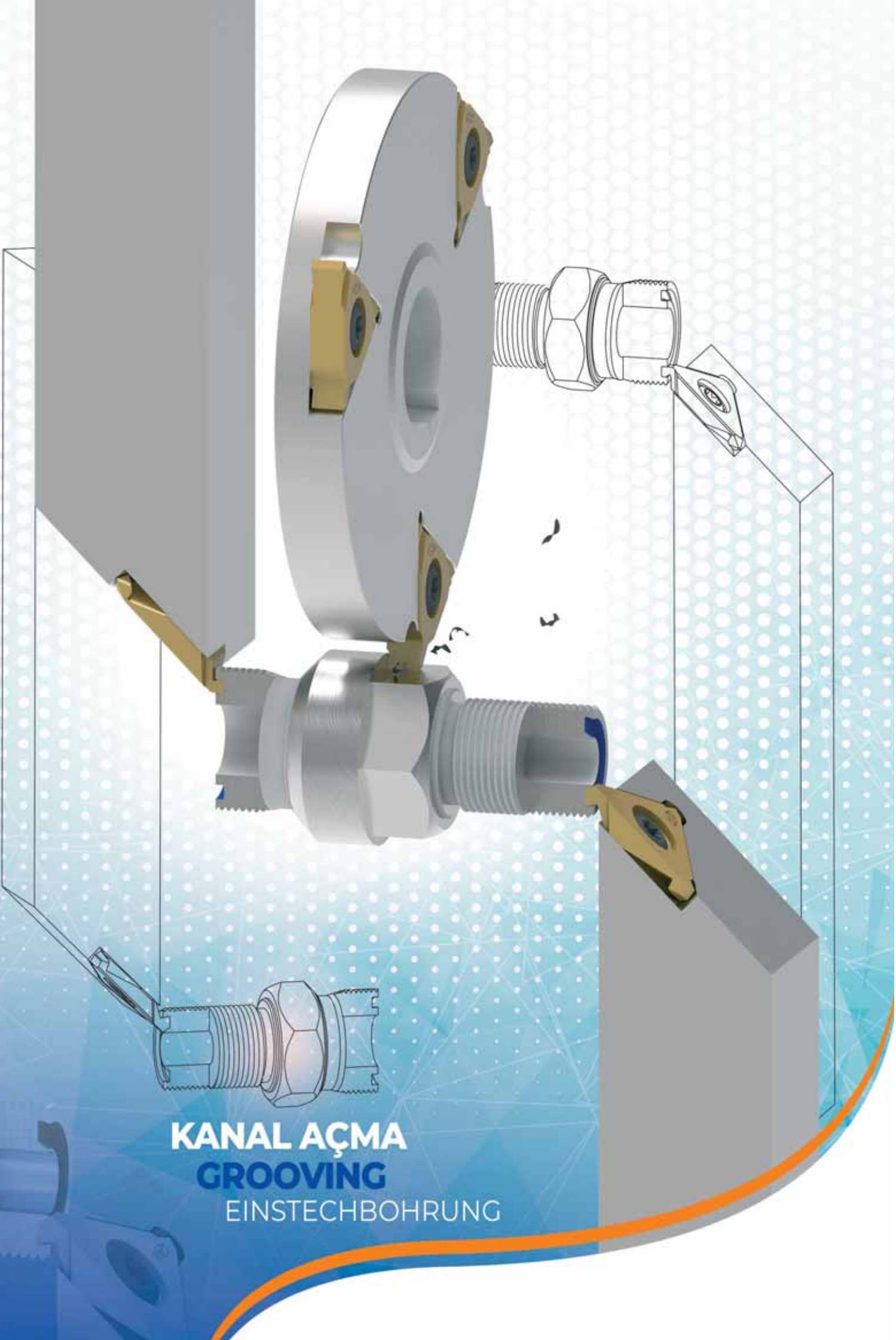

**KANAL AÇMA**  
**GROOVING**  
EINSTECHBOHRUNG

# BROŞ

**BROŞ ÇEKME UÇLARI ve TAKIMLARI**

*BROACHING INSERTS and TOOLHOLDERS*

*WENDESCHEIDPLATTEN UND WERKZEUGHALTER FÜR  
DIE NUTBEARBEITUNG*

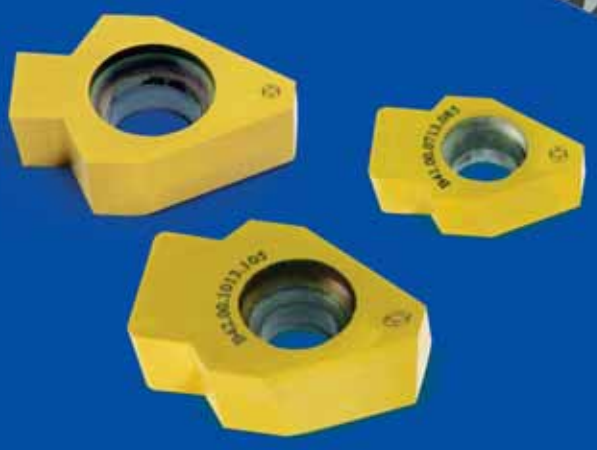



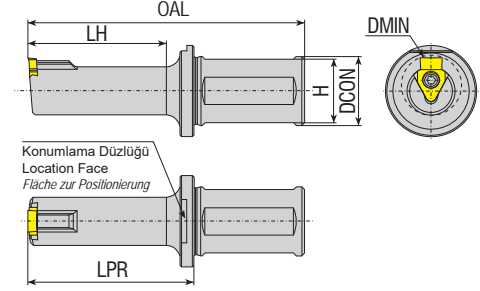

Takım Kodu Ordering Code Bestell-Bezeichnung	Stok Stock Lager	Takım Ölçüleri (mm) Dimension (mm) Abmessung (mm)						Kesici Uç Insert Wendescheidplatte	Yedek Parçaları / Spare Parts / Ersatzteile	
		DMIN	LH	DCON	OAL	LPR	H		Sıkma Vidası Screw Schraube	Tork Anahtar Torx Key Torx-Schlüssel
ABT-B41-D17-Y25-L90-I040	●	17	40	25	90	50	23	B41...	4015-M4x11	80-T15
ABT-B41-D17-Y25-L105-I065	●	17	65	25	105	75	23			
ABT-B41-D22-Y25-L100-I050	●	22	50	25	100	60	23			
ABT-B41-D22-Y25-L125-I070	●	22	70	25	125	80	23			
ABT-B42-D30-Y32-L100-I050	●	30	50	32	100	60	30	B42...	1020-M5x14	80-T20
ABT-B42-D30-Y32-L125-I075	●	30	75	32	125	85	30			
ABT-B42-D30-Y32-L170-I110	●	30	110	32	170	120	30			
ABT-B42-D38-Y32-L100-I050	●	38	50	32	100	60	30			
ABT-B42-D38-Y32-L125-I075	●	38	75	32	125	85	30			
ABT-B42-D40-Y32-L100-I050	●	40	50	32	100	60	30			
ABT-B42-D40-Y32-L125-I075	●	40	75	32	125	85	30			



DIN138 (Tolerans C11) torna ve freze tezgahlarında broş çekme uçları.  
DIN138 (Tolerance C11) inserts for keyway broaching on lathe and milling machines.  
DIN 138 (Toleranz C11) Wendeplatten für Keilnutenfertigung auf Dreh- und Fräsmaschinen

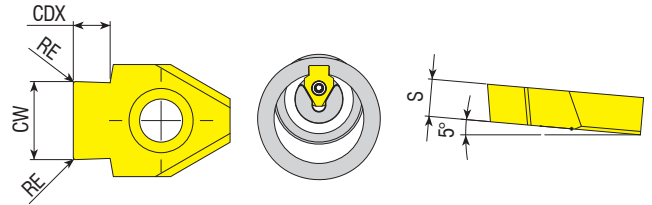

Uç Kodu Insert Code Wendeplatten-Bezeichnung	Stok Stock Lager	Uç Ölçüleri (mm) Insert Dimension (mm) Abmessung (mm)					UYUMLU TAKIM / COMPATIBLE TOOLHOLDER / KOMPATIBLES WERKZEUG
		CW	RE	CDX	S	DMIN	
B41.00.0612.085.VP3001	●	6.12	0.85	2.6	4.0	22	ABT-B41-D22...
B41.00.0713.085.VP3001	●	7.13	0.85	3.3	4.0	22	
B41.00.0813.105.VP3001	●	8.13	1.05	3.4	4.0	22	
B42.00.1013.105.VP3001	●	10.13	1.05	4.2	6.0	30	ABT-B42-D30...
B42.00.1215.135.VP3001	●	12.15	1.35	5.1	6.0	38	ABT-B42-D38...
B42.00.1215.175.VP3001	●	12.15	1.75	6.6	6.0	38	
B42.00.1215.225.VP3001	●	12.15	2.25	8.5	6.0	38	

Tipik kesme şartları / Typical cutting conditions / Tipik kesme şartları / Typical cutting conditions / Standard-Schneidbedingungen: İlerleme (Vf): 3000-8000 mm/dak (min)  
/ Paso (ap): 0.02-0.08 mm / Vorschub (Vf): 3000-8000 mm/min

R: Sağ / Right / Rechts L: Sol / Left / Links

● Stokta / In Stock / Auf Lager ○ Stokta Yok / Non Stock Item / Kein Lagerartikel, Lieferzeit auf Anfrage

Sipariş Örneği/Ordering Example/Bestellbeispiel  
1 ad./pcs./stück ABT-B41-D17-Y25-L90-I040

## BROŞ ÇEKME UÇLARI ve TAKIMLARI

BROACHING INSERTS and TOOLHOLDERS

WENDESCHNEIDPLATTEN UND WERKZEUGHALTER FÜR DIE NUTBEARBEITUNG



DIN6885 (Tolerans P9) torna ve freze tezgahlarında broş çekme uçları.  
DIN6885 (Tolerance P9) inserts for keyway broaching on lathe and milling machines.  
DIN6885 (Toleranz P9) Wendeplatten für Keilnutenfertigung auf Dreh- und Fräsmaschinen

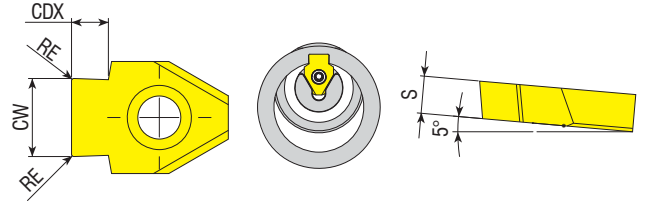

### Uç Kodu

Insert Code

Wendeplatten-Bezeichnungeidplatte

Stok  
Stock  
Lager

Uç Ölçüleri (mm)  
Insert Dimension (mm)  
Abmessung (mm)

Uç Kodu Insert Code Wendeplatten-Bezeichnungeidplatte	Stok Stock Lager	CW	RE	CDX	S	DMIN	UYUMLU TAKIM / COMPATIBLE TOOLHOLDER / KOMPATIBLES WERKZEUG
B41.00.0498.020.VP3001	●	4.98	0.20	2.7	4.0	17	ABT-B41-D17
B41.00.0598.020.VP3001	●	5.98	0.20	3.4	4.0	17	ABT-B41-D17
B41.00.0798.020.VP3001	●	7.98	0.20	4.1	4.0	22	ABT-B41-D22
B42.00.0998.030.VP3001	●	9.98	0.30	4.2	6.0	30	ABT-B42-D30
B42.00.1197.030.VP3001	●	11.97	0.30	5.7	6.0	38	ABT-B42-D38
B42.00.1397.030.VP3001	●	13.97	0.30	6.8	6.0	40	ABT-B42-D40

Tipik kesme şartları / Typical cutting conditions / Standard-Schneidbedingungen: İlerleme (Vf): 3000-8000 mm/dak (min) / Paso (ap): 0.02-0.08 mm / Vorschub (Vf): 3000-8000 mm/min



DIN6885 (Tolerans JS9) torna ve freze tezgahlarında broş çekme uçları.  
DIN6885 (Tolerance JS9) inserts for keyway broaching on lathe and milling machines.  
DIN6885 (Toleranz JS9) Wendeplatten für Keilnutenfertigung auf Dreh- und Fräsmaschinen

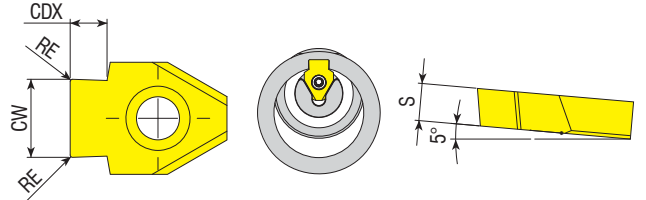

### Uç Kodu

Insert Code

Wendeplatten-Bezeichnungeidplatte

Stok  
Stock  
Lager

Uç Ölçüleri (mm)  
Insert Dimension (mm)  
Abmessung (mm)

Uç Kodu Insert Code Wendeplatten-Bezeichnungeidplatte	Stok Stock Lager	CW	RE	CDX	S	DMIN	UYUMLU TAKIM / COMPATIBLE TOOLHOLDER / KOMPATIBLES WERKZEUG
B41.00.0501.020.VP3001	●	5.01	0.20	2.7	4.0	17	ABT-B41-D17
B41.00.0601.020.VP3001	●	6.01	0.20	3.4	4.0	17	ABT-B41-D17
B41.00.0801.020.VP3001	●	8.01	0.20	4.1	4.0	22	ABT-B41-D22
B42.00.1001.030.VP3001	●	10.01	0.30	4.2	6.0	30	ABT-B42-D30
B42.00.1200.050.VP3001	●	12.00	0.50	8.5	6.0	38	ABT-B42-D38
B42.00.1201.030.VP3001	●	12.01	0.30	5.7	6.0	38	ABT-B42-D38
B42.00.1401.030.VP3001	●	14.01	0.30	6.8	6.0	40	ABT-B42-D40

Tipik kesme şartları / Typical cutting conditions / Standard-Schneidbedingungen: İlerleme (Vf): 3000-8000 mm/dak (min) / Paso (ap): 0.02-0.08 mm / Vorschub (Vf): 3000-8000 mm/min



Torna ve freze tezgahlarında kama kanalı pah kırma uçları.  
Inserts for keyway chamfering on lathe and milling machines.  
Wendeschnidplatten zum Anfasen von Keilnuten auf Dreh- und Fräsmaschinen

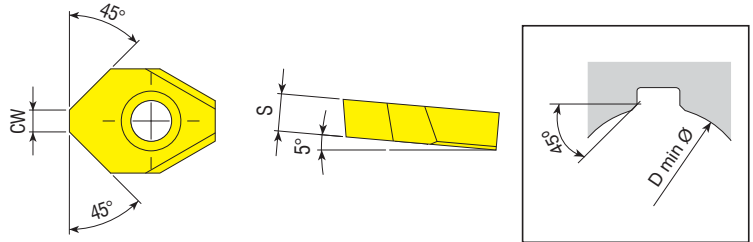

### Uç Kodu

Insert Code

Wendeplatten-Bezeichnungeidplatte

Stok  
Stock  
Lager

Uç Ölçüleri (mm)  
Insert Dimension (mm)  
Abmessung (mm)

Uç Kodu Insert Code Wendeplatten-Bezeichnungeidplatte	Stok Stock Lager	DMIN	CW	S	UYUMLU TAKIM / COMPATIBLE TOOLHOLDER / KOMPATIBLES WERKZEUG
B41.00.0150.CH.VP3001	●	17	1.5	4.0	ABT-B41-D17
B41.00.0300.CH.VP3001	●	22	3.0	4.0	ABT-B41-D22
B42.00.0600.CH.VP3001	●	30	6.0	6.0	ABT-B42-D30

Tipik kesme şartları / Typical cutting conditions / Standard-Schneidbedingungen: İlerleme (Vf): 3000-8000 mm/dak (min) / Paso (ap): 0.02-0.08 mm / Vorschub (Vf): 3000-8000 mm/min

R: Sağ / Right / Rechts L: Sol / Left / Links

● Stokta / In Stock / Auf Lager ○ Stokta Yok / Non Stock Item / Kein Lagerartikel, Lieferzeit auf Anfrage

Sipariş Örneği/Ordering Example/Bestellbeispiel

1 ad./pcs./stück B41.00.0498.020.VP3001



www.akk.com.tr

PROFİL VERİLMİŞ UÇLAR / PROFILED INSERTS / PROFIL-WENDESCHNEIDPLATTEN  
ÖRNEK PROFİLLER / EXAMPLES OF PROFILES / BEISPIELE FÜR PROFILE

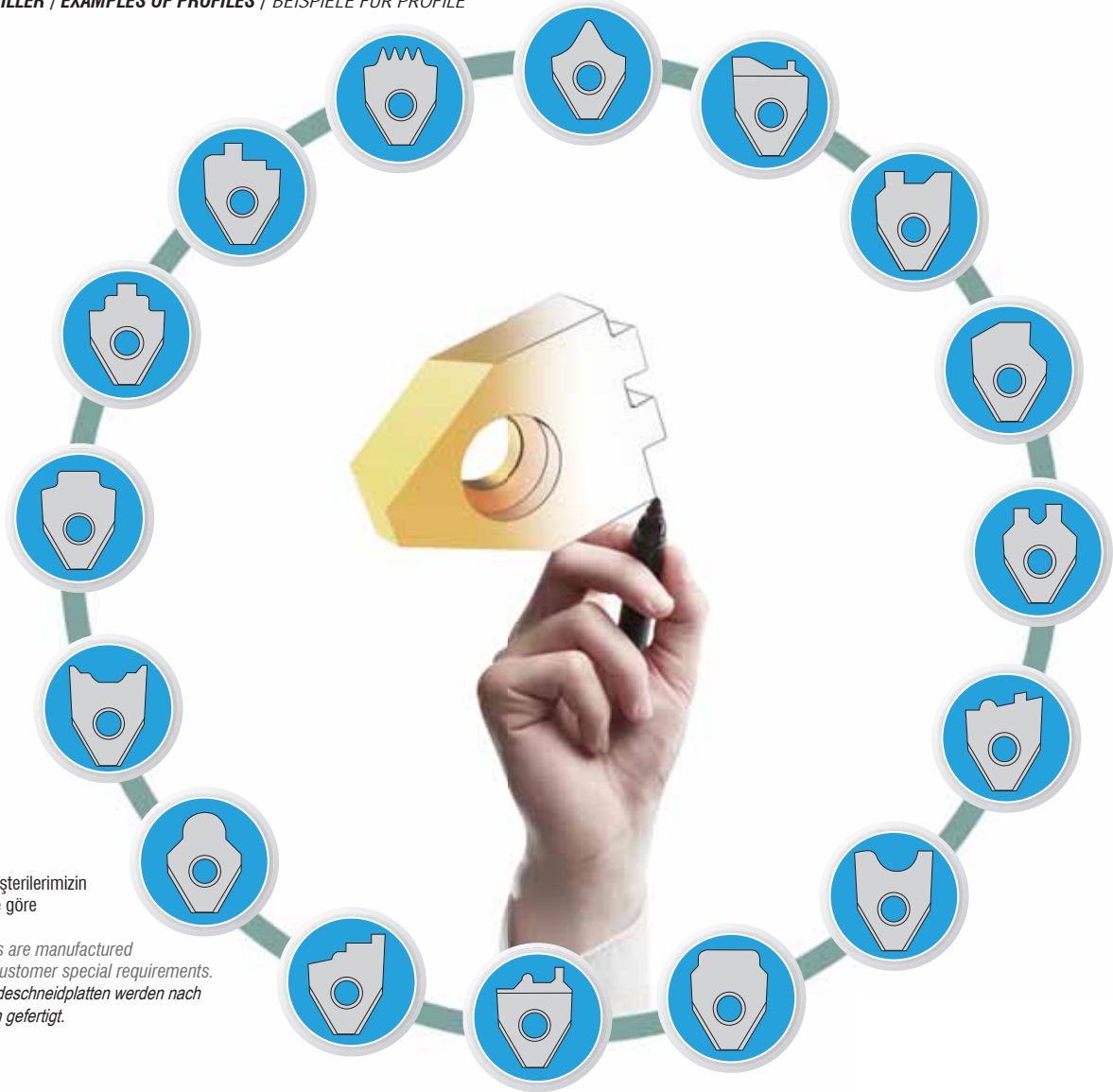

Profil uçlar müşterilerimizin özel taleplerine göre üretilmektedir.  
Profiled inserts are manufactured according to customer special requirements.  
Die Profil-Wendeschnidplatten werden nach Kundenwunsch gefertigt.



Üretmemizi istediğiniz Uçun teknik özelliklerini veya bir örneğini bize gönderin.  
Send us the technical specifications or a sample of the insert you want to produce.  
Bitte lassen Sie uns ein exemplar sowie die technischen Einzelheiten der gewünschten Wendeschnidplatte zukommen.

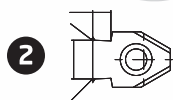

Sizin için bir teklif hazırlayalım.  
We prepare an offer for you.  
Wir werden für Sie ein Angebot vorbereiten.



Üretimi yapıp size gönderebiliriz.  
We produce it and ship it to you.  
Wir werden es produzieren und Ihnen ausliefern.

BROŞ UCU BİLGİ ALMA FORMU / BROACHING INSERT INFORMATION FORM / INFORMATIONSBLATT FÜR DIE WENDESCHNEIDPLATTE DER NUTBEARBEITUNG

Broş ve Delik Ölçüleri / Dimension of Bore / Maße von Bohrungsdurchmesser und Nuten

b			
t			
r			
d/min*			
İş Parçası Malzemesi Work Material Werkstückmaterial			
Tolerans Grubu / Tolerance Group / Toleranzgruppe			
C11	P9	JS9	CUSTOM

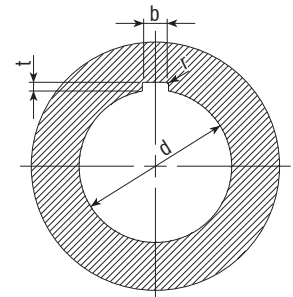

## TULIP HEADS

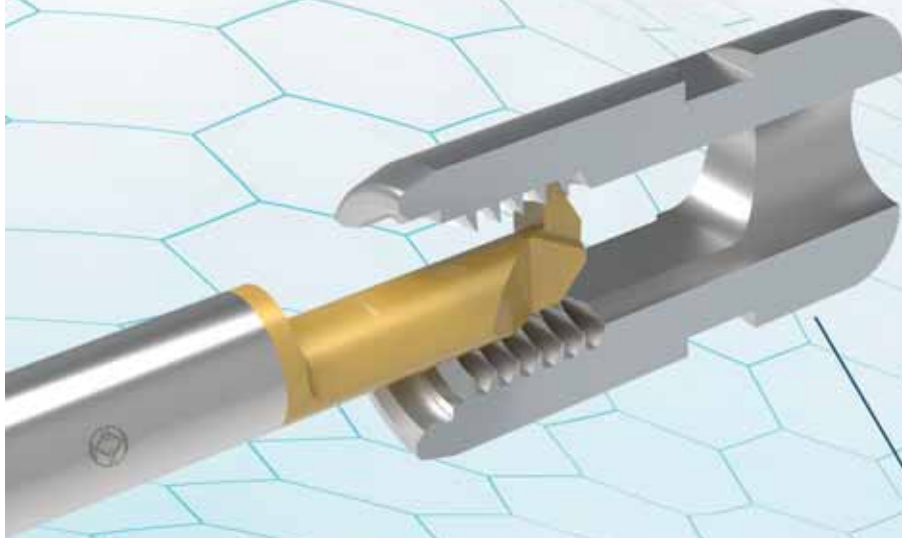
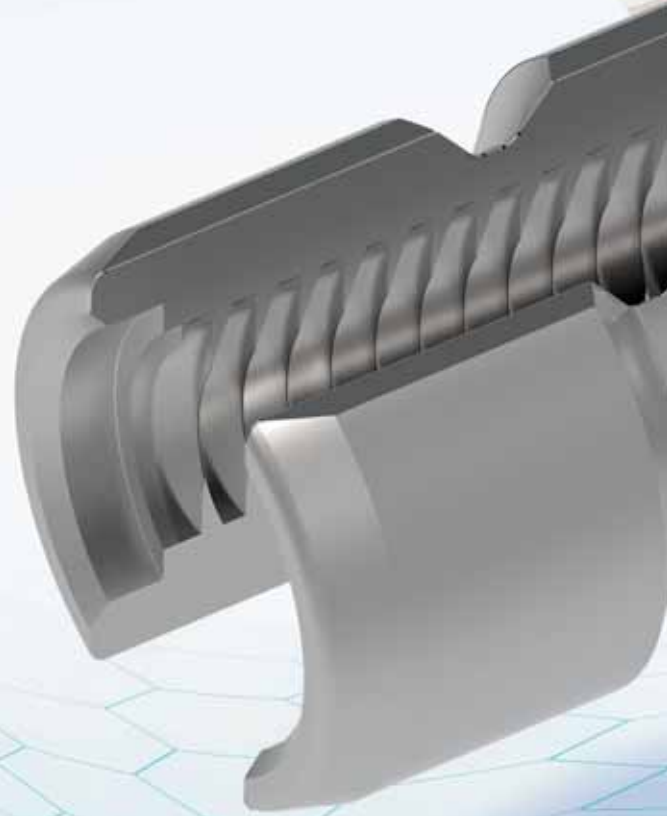

**DIŞ AÇMA**  
**THREADING**  
*GEWINDE*

DELİK İÇİ  
TORNALAMA

**BORING**  
BOHREN

ÖZEL FORMA AÇMA

**SPECIAL FORMING**

SONDER FORM BEARBEITUNG

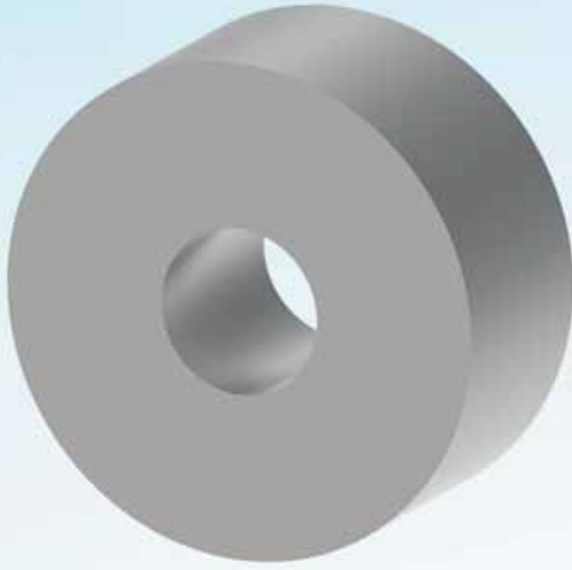

# IMPLANT NUT

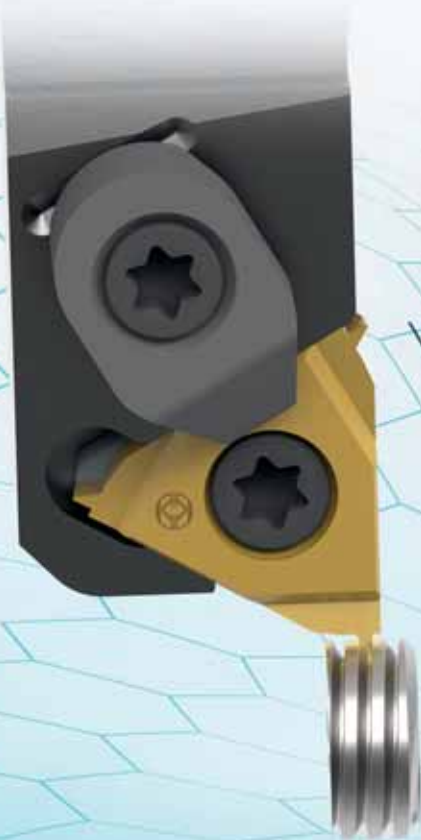
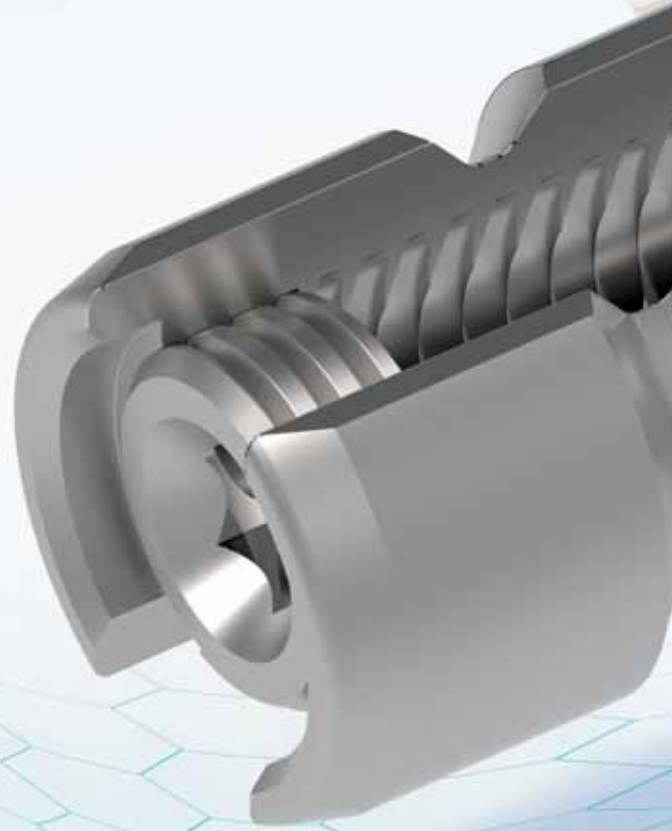

DIŞ AÇMA  
**THREADING**  
GEWINDE



**ALIN ÖZEL FORM**  
**FACE SPECIAL  
FORMING**  
*ALIN SONDERFORM*

**ALYAN PUNCH**

**ALLEN PUNCH**  
*WINKELSCHRAUBENDEHER  
WERKZEUGE*

**WHIRLING**  
**WHIRLING**  
*WENDESCHNEIDPLATTEN*

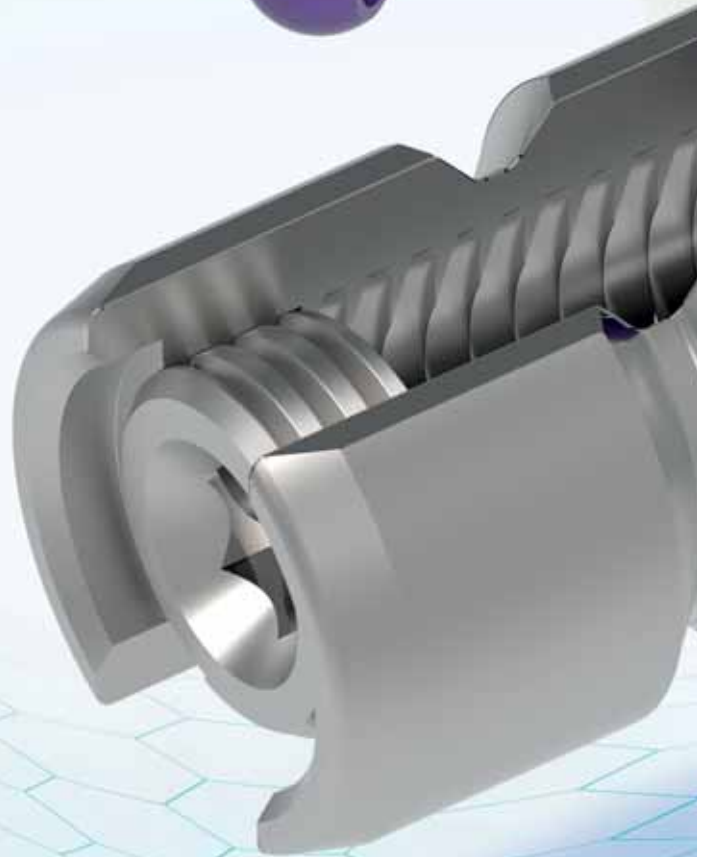
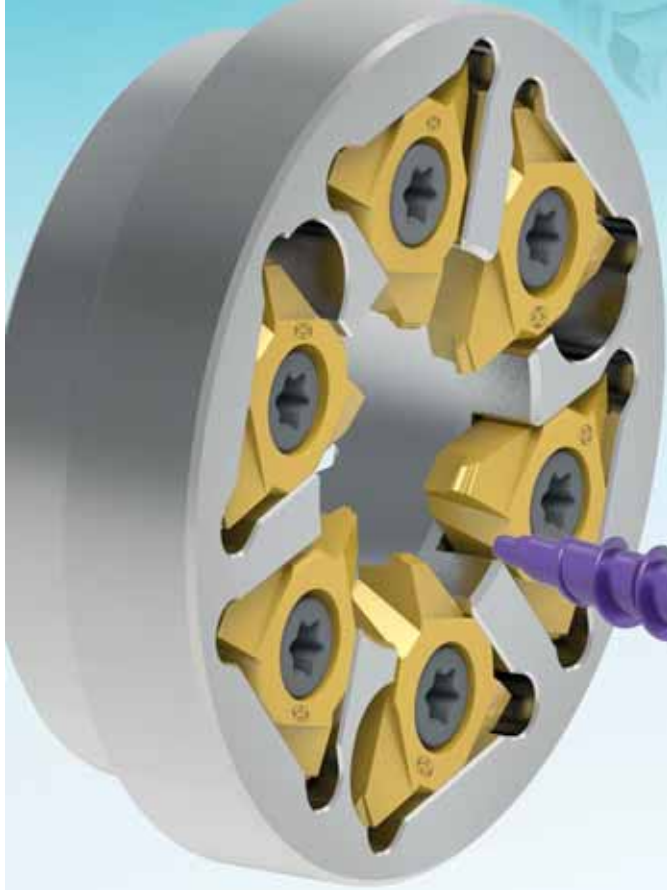

**ALYAN / PUNCH - KAZIMA**

**ALLEN / PUNCH - BROACH**  
*WINKELSCHRAUBENDEHER  
WERKZEUGE*

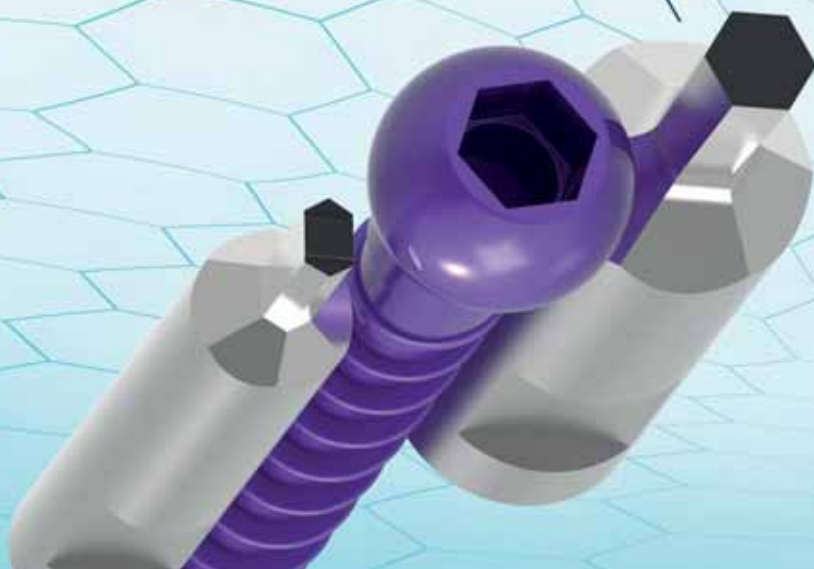



# IMPLANT SCREW

TORX / PUNCH - KAZIMA

**TORX / PUNCH - BROACH**  
WINKELSCHRAUBENDREHER - RING

# WHIRLING

**WHIRLING UÇLARI ve TAKIMLARI**

*WHIRLING INSERTS and TOOLHOLDERS*

*WENDESCHNEIDPLATTEN UND WERKZEUGHALTER ZUM  
GEWINDEWIRBELN*



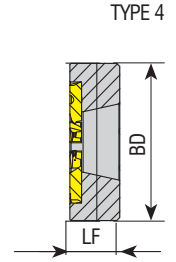
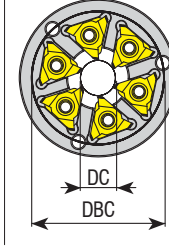
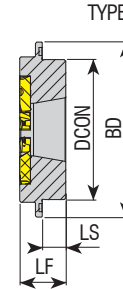
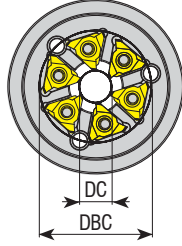
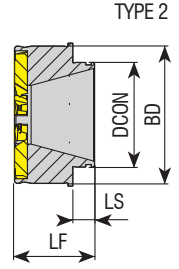
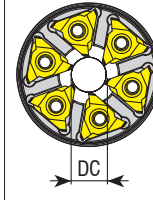
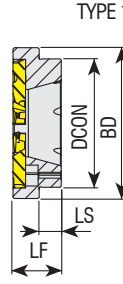
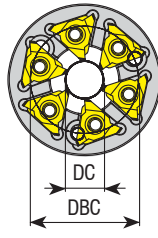

Makine Machine Maschine	Tahrikli WHIRLING Ünitesi Aggregate WHIRLING Unit Wirbelspindel	WHIRLING Ring Kodu WHIRLING Ring Code Wirbelring	Stok Stock Lager	Takım Ölçüleri (mm) Dimension (mm) Abmessung (mm)								Kesici Uç Insert Wendeschnidplatte	Yedek Parçaları / Spare Parts / Ersatzteile	
				ZEPF	DC	DCON	DBC	BD	LS	LF	TYPE		Sıkma Vidası Screw Schraube	Tork Anahtar Torx Key Torx-Schlüssel
STAR	5914 72 00/68172	ATW-301-T09-D1240-Z06	●	6	12	40	33	47	7	15	1	T09...	4015 M4x11	80-T15
CITIZEN	BTW1000	ATW-302-T09-D1233-Z06	○	6	12	33	40	47	4	18.5	-			
	GSW101	ATW-303-T09-D0620-Z06	○	6	6	20	26	35	3.2	15	1			
	MWS101/KSW101	ATW-304-T09-D1240-Z06	○	6	12	40	32.5	46	2.5	15.5	1			
	LSW101/BSW215/ LSW215315		○	6	12	40	32.5	46	2.5	15.5	1			
	LSW424		ATW-305-T09-D1245-Z06	○	6	12	45	30	46	9.5	18			
TORNOS	306101/307087	ATW-306-T09-D1240-Z06	●	6	12	40	31	57	3.5	15	-			
	417617	ATW-307-T09-D1250-Z06	○	6	12	50	40	67	3.5	15.4	-			
WTO	TN762004	ATW-308-T09-D1142-Z06	●	6	11	31.97	-	42	6.7	24.7	2			
	TN762006	ATW-309-T09-D2054-Z08	○	8	20	56.5	-	54	1.5	13.8	2			
TSUGAMI	3234 Y342	ATW-310-T09-D1252-Z06	●	6	12	52	42	65	8.7	17	3			
	3268 Y452	ATW-311-T09-D1252-Z06	○	6	12	52	44	52	10	10	3			
	3268 Y271	ATW-312-T09-D1252-Z06	○	6	12	52	38	54	6	19	3			
	3214 Y342	ATW-313-T09-D1650-Z06	○	6	16	50	40	62	8.5	20	3			
	3234 Y342	ATW-314-T09-D2052-Z06	○	6	20	52	42	65	8.7	17	3			
	3281-Y451	ATW-316-T09-D1252-Z06	●	6	12	52	44	52	-	17	4			
HANWHA	MADAULA	ATW-315-T09-D1245-Z06	○	6	12	45	-	56	8.5	15	1			

R: Sağ / Right / Rechts L: Sol / Left / Links

● Stokta / In Stock / Auf Lager ○ Stokta Yok / Non Stock Item / Kein Lagerartikel, Lieferzeit auf Anfrage

Sipariş Örneği/Ordering Example/Bestellbeispiel

1 ad./pcs./stück ATW-301-T09-D1240-Z06

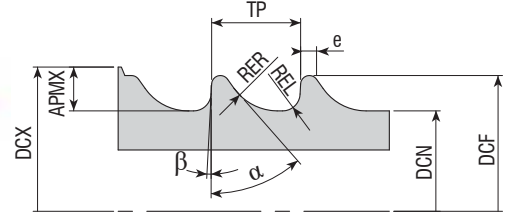
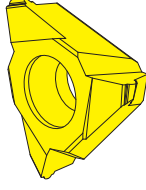

Uç Kodu Insert Code Wendepplatten-Bezeichnung	Kalite Grade Sorte		Standart ISO5835	Uç Ölçüleri (mm) Insert Dimension (mm) Abmessung (mm)									
	VK15U	VK15U01		TP	e	DCF	DCN	RER	REL	$\alpha$	$\beta$	APMX	DCX
T09.HA150.D12	●	●	HA1.5	0.5	0.1	1.35 to 1.5	1.0 to 1.1	0.30	0.1	35°	3°	4	9
T09.HA200.D12	●	●	HA2.0	0.6	0.1	1.85 to 2.0	1.2 to 1.3	0.40	0.1	35°	3°	4	9
T09.HA270.D12	●	●	HA2.7	1	0.1	2.55 to 2.7	1.75 to 1.9	0.60	0.2	35°	3°	4	9.5
T09.HA350.D12	●	●	HA3.5	1.25	0.1	3.35 to 3.5	2.25 to 2.4	0.80	0.2	35°	3°	4	10
T09.HA400.D12	●	●	HA4.0	1.5	0.1	3.85 to 4.0	2.75 to 2.9	0.80	0.2	35°	3°	4	10.5
T09.HA450.D12	●	●	HA4.5	1.75	0.1	4.35 to 4.5	2.85 to 3.0	1.00	0.3	35°	3°	4	11
T09.HA500.D12	●	●	HA5.0	1.75	0.1	4.85 to 5.0	3.35 to 3.5	1.00	0.3	35°	3°	4	11
T09.HB400.D12	●	●	HB4.0	1.75	0.1	3.85 to 4.0	1.75 to 1.9	0.80	0.3	25°	5°	4	9.5
T09.HB650.D12	●	●	HB6.5	2.75	0.2	6.35 to 6.5	2.85 to 3.0	1.20	0.8	25°	5°	4	11

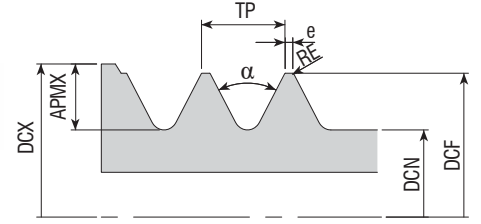
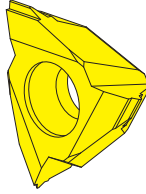
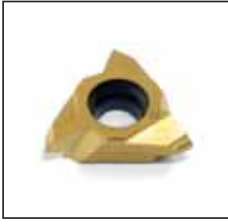

Uç Kodu Insert Code Wendepplatten-Bezeichnung	Kalite Grade Sorte		Standart ISO9268	Uç Ölçüleri (mm) Insert Dimension (mm) Abmessung (mm)							
	VK15U	VK15U01		TP	e	DCF	DCN	$\alpha$	RE	APMX	DCX
T09.HC290.D12	○	○	HC2.9	1.06	0.1	2.79 to 2.90	2.03 to 2.18	60°	0.01	4	10.5
T09.HC350.D12	○	○	HC3.5	1.27	0.1	3.43 to 3.53	2.51 to 2.64	60°	0.01	4	11
T09.HC390.D12	○	○	HC3.9	1.27	0.1	3.78 to 3.91	2.77 to 2.92	60°	0.01	4	11.5
T09.HC420.D12	○	○	HC4.2	1.27	0.1	4.09 to 4.22	2.95 to 3.25	60°	0.01	4	12

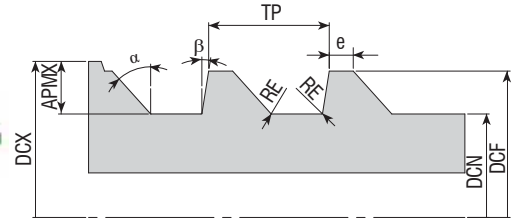
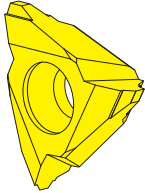
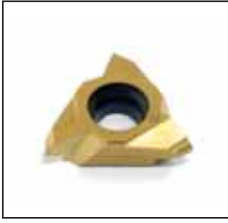

Uç Kodu Insert Code Wendepplatten-Bezeichnung	Kalite Grade Sorte		Standart ISO9268	Uç Ölçüleri (mm) Insert Dimension (mm) Abmessung (mm)								
	VK15U	VK15U01		TP	e	DCF	DCN	RE	$\alpha$	$\beta$	APMX	DCX
T09.HD400.D12	○	○	HD4.0	1.59	0.1	3.97 to 4.03	2.89 to 2.95	0.01	45°	10°	4	11.5
T09.HD450.D12	○	○	HD4.5	2.18	0.1	4.47 to 4.53	2.89 to 2.95	0.01	45°	10°	4	12

R: Sağ / Right / Rechts L: Sol / Left / Links  
● Stokta / In Stock / Auf Lager ○ Stokta Yok / Non Stock Item / Kein Lagerartikel, Lieferzeit auf Anfrage

Sipariş Örneği/Ordering Example/Bestellbeispiel  
1 ad./pcs./stück T09.HA150.D12

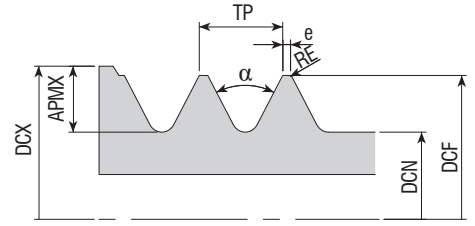
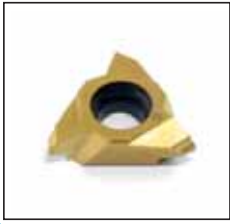

Uç Kodu Insert Code Wendeplatten-Bezeichnung	Kalite Grade Sorte		Standart DIN13	Uç Ölçüleri (mm) Insert Dimension (mm) Abmessung (mm)						
	VK15U	VK15U01		TP	DCF	DCN	a	RE	APMX	DCX
T09.M200.D12	●	●	M2	0.4	2	1.509	60	0.048	4	9
T09.M250.D12	●	●	M2.5	0.45	2.5	1.928	60	0.055	4	9.5
T09.M300.D12	●	●	M3	0.5	3	2.387	60	0.062	4	10
T09.M350.D12	●	●	M3.5	0.6	3.5	2.744	60	0.077	4	8.5
T09.M400.D12	●	●	M4.0	0.7	4	3.141	60	0.091	4	11
T09.M500.D12	●	●	M5.0	0.8	5	4.019	60	0.105	4	11.5
T09.M600.D12	●	●	M6.0	1	6	4.773	60	0.134	4	12.5
T09.M700.D12	●	●	M7.0	1	7	5.753	60	0.134	4	13.5
T09.M800.D12	●	●	M8.0	1.25	8	6.446	60	0.17	4	14

Kesme başlangıç pozisyonu  
Cutting Start Position  
Startposition Schneidvorgang

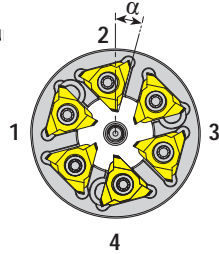

Y Eksen  
Y Axis  
Y Oc̄b

İş parçası dönüş yönü  
Turning Direction of Workpiece  
Drehrichtung Werkstück

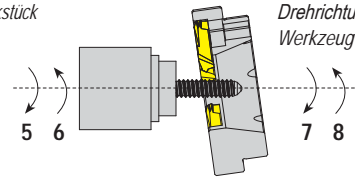

WHIRLING ünitesi dönüş yönü  
Turning Direction of WHIRLING unit  
Drehrichtung Gewindewirbel  
Werkzeug

Makine Özellikleri Machine Specifications Angaben zur Maschine			Malzeme Özellikleri Material Specifications Material Besonderheiten		
<b>Makine Üreticisi</b> Machine Manufacturer Maschinenhersteller			<b>Malzeme (DIN, AISI v.b.)</b> Material (DIN, AISI etc.) Material DIN, AISI etc.		
<b>Makine Modeli</b> Machine Model Maschinenbezeichnung			<b>Ham Malzeme Çapı</b> Raw Material Diameter Rohmaterial Durchmesser		
<b>Tahrikli WHIRLING Ünitesi Üreticisi</b> Live Tool Manufacturer Hersteller angetriebene Werkzeuge			<b>Diş Profili</b> Thread Profile Gewindeprofil		
<b>Tahrikli WHIRLING Ünitesi</b> Aggregate WHIRLING Unit Wirbelspindel			<b>Profil Teknik Resmi</b> Profile Technical Drawing Profilzeichnung		
<b>Y - Eksen</b> Y - Axis Y - Achse	<b>Var</b> Exist Ja	<b>Yok</b> None Nein	<b>Hatve</b> Pitch Steigung		
<b>Yüksek Basıncılı Soğutma</b> High Pressure Coolant Hochdruckkühlung	<b>Var</b> Exist Ja	<b>Yok</b> None Nein	<b>Tek Ağız</b> One Start Eingängig		
<b>Kesme Başlangıç Pozisyonu</b> Cutting Start Position Startposition Schneidvorgang	1 <input type="checkbox"/>	2 <input type="checkbox"/>	3 <input type="checkbox"/>	4 <input type="checkbox"/>	<b>İki Ağız</b> Two Starts Zweigängig
<b>WHIRLING Ünitesi Dönüş Yönü</b> Turning Direction of WHIRLING Unit Drehrichtung Gewindewirbel-Werkzeug	5 <input type="checkbox"/>	6 <input type="checkbox"/>	<b>Müşteri Adı / Customer Name / Kundename:</b>		
<b>İş Parçası Dönüş Yönü</b> Turning Direction of Workpiece Drehrichtung Werkstück	7 <input type="checkbox"/>	8 <input type="checkbox"/>	<b>Yetkili / Responsible Person / Ansprechpartner :</b>		
<b>α Açısı</b> α Angle Winkel	<b>Not: Bu açı ürün performansına etki ettiğinden bildirilmesi gerekmektedir. Aksi halinde ring tarafımıza gönderilmelidir.</b> Note: This angle effects the performance of inserts. If doesn't known, tool body should be send to AKKO. Hinweis: Dieser Winkel beeinflusst die Leistung der Wendschneidplatte. Sollte dieser Winkel unbekannt sein, können Sie das Werkzeug zur Fa. AKKO schicken.				
<b>Not / Note / Notizen :</b>					

# MINI CUT TAKIMLAR

MINI CUT TOOLS

MINI CUT WERKZEUGE

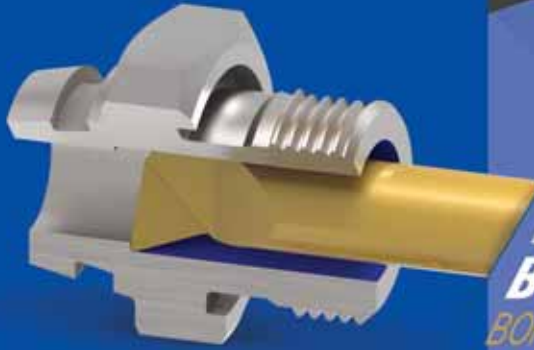

01

DELİK İÇİ TORNALAMA  
**BORING**  
BOHREN



02

DIŞ AÇMA  
**THREADING**  
GEWINDE



03

KANAL AÇMA  
**GROOVING**  
EINSTECHBOHRUNG



04

YÜZEY KANAL AÇMA  
**FACE GROOVING**  
OBERFLÄCHENEINSTECHBOHRUNG

## MINI CUT BORING

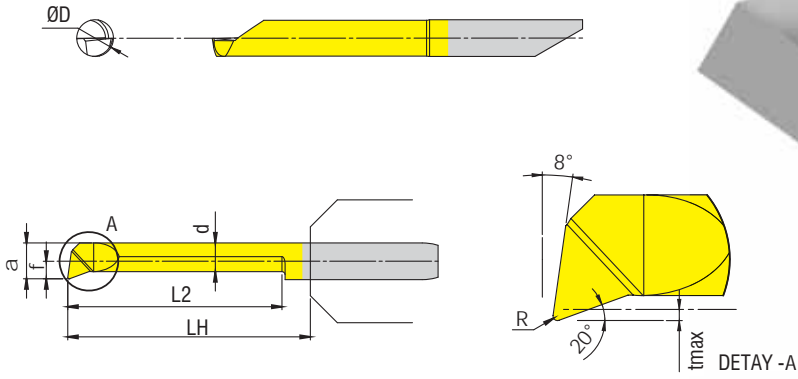

Ürün Kodu  
Product Code  
Artikelnummer

Takım Ölçüleri (mm)  
Dimension (mm)  
Abmessung (mm)

	L2	Ødmin	R	a	d	f	LH	tmax	ØD
VPB.04.102.015	10,2	4.2	0.15	3.95	3.45	1.95	13	0.3	4
VPB.04.152.015	15.20	4.2	0.15	3.95	3.45	1.95	18	0.3	4
VPB.04.203.015	20.30	4.2	0.15	3.95	3.45	1.95	23	0.3	4
VPB.04.254.015	25.40	4.2	0.15	3.95	3.45	1.95	28	0.3	4
VPB.04.305.015	30.50	4.2	0.15	3.95	3.45	1.95	33	0.3	4
VPB.04.356.015	35.60	4.2	0.15	3.95	3.45	1.95	38	0.3	4
VPB.05.102.020	10,2	5.2	0.2	4.95	4.95	2.95	13	0.5	5
VPB.05.152.020	15.20	5.2	0.2	4.95	4.95	2.95	18	0.5	5
VPB.05.203.020	20.30	5.2	0.2	4.95	4.95	2.95	23	0.5	5
VPB.05.254.020	25.40	5.2	0.2	4.95	4.95	2.95	28	0.5	5
VPB.05.305.020	30.50	5.2	0.2	4.95	4.95	2.95	33	0.5	5
VPB.05.356.020	35.60	5.2	0.2	4.95	4.95	2.95	38	0.5	5
VPB.05.406.020	40.60	5.2	0.2	4.95	4.95	2.95	43	0.5	5
VPB.06.102.020	10,2	6.2	0.2	5.95	5.25	2.95	13	0.5	6
VPB.06.152.020	15.20	6.2	0.2	5.95	5.25	2.95	18	0.5	6
VPB.06.203.020	20.30	6.2	0.2	5.95	5.25	2.95	23	0.5	6
VPB.06.254.020	25.40	6.2	0.2	5.95	5.25	2.95	28	0.5	6
VPB.06.305.020	30.50	6.2	0.2	5.95	5.25	2.95	33	0.5	6
VPB.06.356.020	35.60	6.2	0.2	5.95	5.25	2.95	38	0.5	6
VPB.06.406.020	40.60	6.2	0.2	5.95	5.25	2.95	43	0.5	6
VPB.06.508.020	50.80	6.2	0.2	5.95	5.25	2.95	53	0.5	6
VPB.07.254.020	25.40	7.2	0.2	6.95	6.25	3.45	28	0.5	7
VPB.07.305.020	30.50	7.2	0.2	6.95	6.25	3.45	33	0.5	7
VPB.07.356.020	35.60	7.2	0.2	6.95	6.25	3.45	38	0.5	7
VPB.07.406.020	40.60	7.2	0.2	6.95	6.25	3.45	43	0.5	7
VPB.07.508.020	50.80	7.2	0.2	6.95	6.25	3.45	53	0.5	7
VPB.07.608.020	60.80	7.2	0.2	6.95	6.25	3.45	63	0.5	7

Sipariş Örneği/Ordering Example/Bestellbeispiel  
1 ad./pcs./stück VPB.04.102.015

## MINI CUT GROOVING

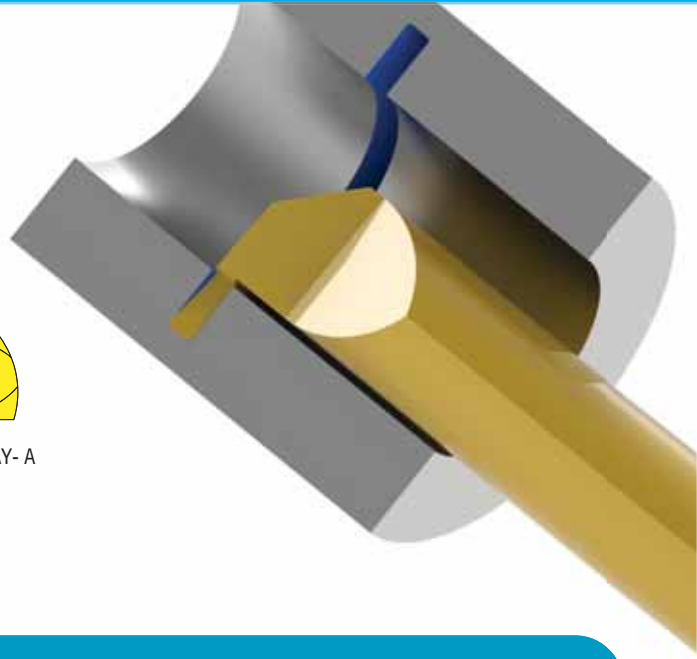
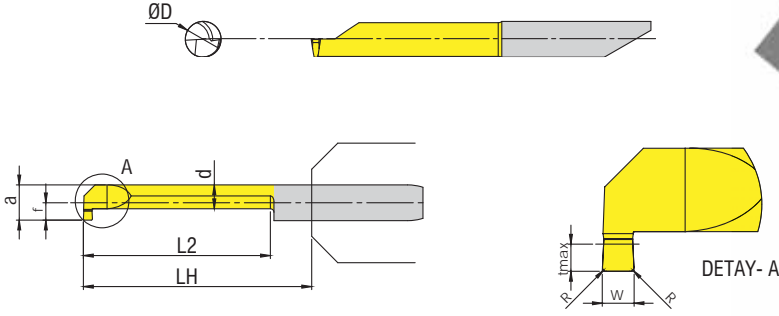

Ürün Kodu  
Product Code  
Artikelnummer

Takım Ölçüleri (mm)  
Dimension (mm)  
Abmessung (mm)

	W	L2	Ødmin	R	a	d	f	LH	tmax	ØD
VPG04.080.102	0,8	10,2	4,2	-	3,95	2,95	1,95	13	0,8	4
VPG04.080.152	0,8	15,2	4,2	-	3,95	2,95	1,95	18	0,8	4
VPG04.080.203	0,8	20,3	4,2	-	3,95	2,95	1,95	23	0,8	4
VPG04.080.254	0,8	25,4	4,2	-	3,95	2,95	1,95	28	0,8	4
VPG04.080.102	1,0	10,2	4,2	-	3,95	2,95	1,95	13	1,0	4
VPG04.080.152	1,0	15,2	4,2	-	3,95	2,95	1,95	18	1,0	4
VPG04.080.203	1,0	20,3	4,2	-	3,95	2,95	1,95	23	1,0	4
VPG05.079.102	0,79	10,2	5,2	-	4,95	3,75	2,45	13	1,0	5
VPG05.079.152	0,79	15,2	5,2	-	4,95	3,75	2,45	18	1,0	5
VPG05.079.203	0,79	20,3	5,2	-	4,95	3,75	2,45	23	1,0	5
VPG05.079.254	0,79	25,4	5,2	-	4,95	3,75	2,45	28	1,0	5
VPG05.079.102	0,79	30,5	5,2	-	4,95	3,75	2,45	33	1,0	5
VPG05.079.152	0,79	35,6	5,2	-	4,95	3,75	2,45	38	1,0	5
VPG05.100.102	1,0	10,2	5,2	-	4,95	3,75	2,45	13	1,0	5
VPG05.100.152	1,0	15,2	5,2	-	4,95	3,75	2,45	18	1,0	5
VPG05.100.203	1,0	20,3	5,2	-	4,95	3,75	2,45	23	1,0	5
VPG05.100.254	1,0	25,4	5,2	-	4,95	3,75	2,45	28	1,0	5
VPG05.100.102	1,0	30,5	5,2	-	4,95	3,75	2,45	33	1,0	5
VPG05.100.152	1,0	35,6	5,2	-	4,95	3,75	2,45	38	1,0	5

Sipariş Örneği/Ordering Example/Bestellbeispiel  
1 ad./pcs./stück VPG04.080.102



## MINI CUT GROOVING

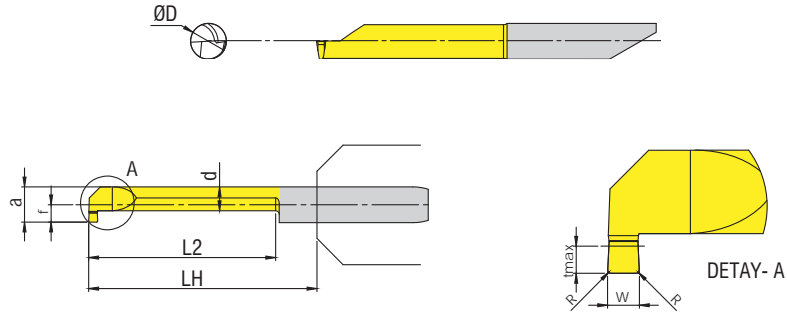

Ürün Kodu  
Product Code  
Artikelnummer

Takım Ölçüleri (mm)  
Dimension (mm)  
Abmessung (mm)

	W	L2	Ødmin	R	a	d	f	LH	tmax	ØD
VPG05.117.102	1,17	10,2	5,2	-	4,95	3,75	2,45	13	1,0	5
VPG05.117.152	1,17	15,2	5,2	-	4,95	3,75	2,45	18	1,0	5
VPG05.117.203	1,17	20,3	5,2	-	4,95	3,75	2,45	23	1,0	5
VPG05.117.254	1,17	25,4	5,2	-	4,95	3,75	2,45	28	1,0	5
VPG05.117.102	1,17	30,5	5,2	-	4,95	3,75	2,45	33	1,0	5
VPG05.117.152	1,17	35,6	5,2	-	4,95	3,75	2,45	38	1,0	5
VPG05.150.102	1,5	10,2	5,2	-	4,95	3,75	2,45	13	1,0	5
VPG05.150.152	1,5	15,2	5,2	-	4,95	3,75	2,45	18	1,0	5
VPG05.150.203	1,5	20,3	5,2	-	4,95	3,75	2,45	23	1,0	5
VPG05.150.254	1,5	25,4	5,2	-	4,95	3,75	2,45	28	1,0	5
VPG05.150.102	1,5	30,5	5,2	-	4,95	3,75	2,45	33	1,0	5
VPG05.150.152	1,5	35,6	5,2	-	4,95	3,75	2,45	38	1,0	5
VPG05.157.102	1,57	10,2	5,2	-	4,95	3,75	2,45	13	1,0	5
VPG05.157.152	1,57	15,2	5,2	-	4,95	3,75	2,45	18	1,0	5
VPG05.157.203	1,57	20,3	5,2	-	4,95	3,75	2,45	23	1,0	5
VPG05.157.254	1,57	25,4	5,2	-	4,95	3,75	2,45	28	1,0	5
VPG05.157.102	1,57	30,5	5,2	-	4,95	3,75	2,45	33	1,0	5

Sipariş Örneği/Ordering Example/Bestellbeispiel  
1 ad./pcs./stück VPG05.117.102

## MINI CUT GROOVING

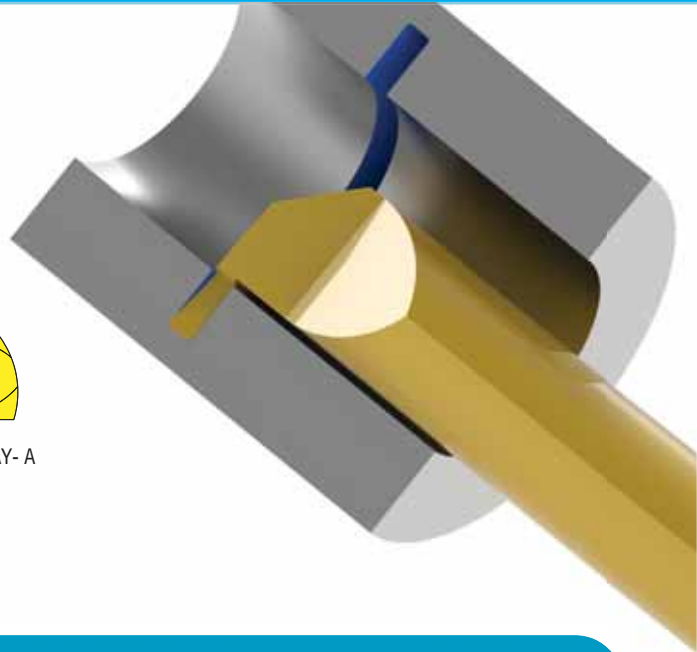
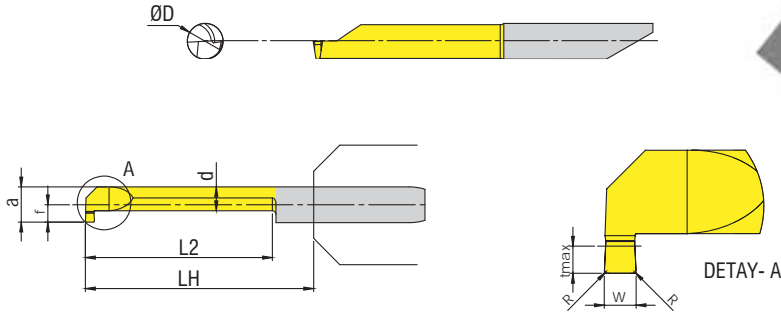

Ürün Kodu  
Product Code  
Artikelnummer

Takım Ölçüleri (mm)  
Dimension (mm)  
Abmessung (mm)

	W	L2	Ødmin	R	a	d	f	LH	tmax	ØD
VPG05.198.102	1,98	10,2	5,2	-	4,95	3,75	2,45	13	1,0	5
VPG05.198.152	1,98	15,2	5,2	-	4,95	3,75	2,45	18	1,0	5
VPG05.198.203	1,98	20,3	5,2	-	4,95	3,75	2,45	23	1,0	5
VPG05.198.254	1,98	25,4	5,2	-	4,95	3,75	2,45	28	1,0	5
VPG05.198.102	1,98	30,5	5,2	-	4,95	3,75	2,45	33	1,0	5
VPG05.200.102	2,0	10,2	5,2	-	4,95	3,75	2,45	13	1,0	5
VPG05.200.152	2,0	15,2	5,2	-	4,95	3,75	2,45	18	1,0	5
VPG05.200.203	2,0	20,3	5,2	-	4,95	3,75	2,45	23	1,0	5
VPG05.200.254	2,0	25,4	5,2	-	4,95	3,75	2,45	28	1,0	5
VPG05.200.102	2,0	30,5	5,2	-	4,95	3,75	2,45	33	1,0	5
VPG06.079.102	0,79	10,2	6,2	-	5,95	3,95	2,95	13	1,8	6
VPG06.079.152	0,79	15,2	6,2	-	5,95	3,95	2,95	18	1,8	6
VPG06.079.203	0,79	20,3	6,2	-	5,95	3,95	2,95	23	1,8	6
VPG06.079.254	0,79	25,4	6,2	-	5,95	3,95	2,95	28	1,8	6
VPG06.079.102	0,79	30,5	6,2	-	5,95	3,95	2,95	33	1,8	6
VPG06.079.152	0,79	35,6	6,2	-	5,95	3,95	2,95	38	1,8	6

Sipariş Örneği/Ordering Example/Bestellbeispiel  
1 ad./pcs./stück VPG05.198.102

## MINI CUT GROOVING

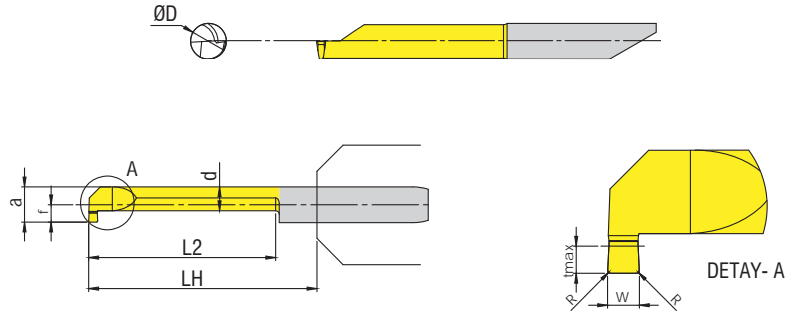

Ürün Kodu  
Product Code  
Artikelnummer

Takım Ölçüleri (mm)  
Dimension (mm)  
Abmessung (mm)

	W	L2	Ødmin	R	a	d	f	LH	tmax	ØD
VPG06.100.102	1,0	10,2	6,2	-	5.95	3.95	2.95	13	1.8	6
VPG06.100.152	1,0	15.2	6.2	-	5.95	3.95	2.95	18	1.8	6
VPG06.100.203	1,0	20.3	6.2	-	5.95	3.95	2.95	23	1.8	6
VPG06.100.254	1,0	25.4	6.2	-	5.95	3.95	2.95	28	1.8	6
VPG06.100.102	1,0	30.5	6.2	-	5.95	3.95	2.95	33	1.8	6
VPG06.100.152	1,0	35.6	6.2	-	5.95	3.95	2.95	38	1.8	6
VPG06.100.153	1,0	40,6	6,2	-	5.95	3.95	2.95	43	1.8	6
VPG06.117.102	1.17	10,2	6,2	-	5.95	3.95	2.95	13	1.8	6
VPG06.117.152	1.17	15.2	6.2	-	5.95	3.95	2.95	18	1.8	6
VPG06.117.203	1.17	20.3	6.2	-	5.95	3.95	2.95	23	1.8	6
VPG06.117.254	1.17	25.4	6.2	-	5.95	3.95	2.95	28	1.8	6
VPG06.117.102	1.17	30.5	6.2	-	5.95	3.95	2.95	33	1.8	6
VPG06.117.152	1.17	35.6	6.2	-	5.95	3.95	2.95	38	1.8	6
VPG06.117.153	1.17	40,6	6,2	-	5.95	3.95	2.95	43	1.8	6
VPG06.150.102	1.5	10,2	6,2	-	5.95	3.95	2.95	13	1.8	6
VPG06.150.152	1.5	15.2	6.2	-	5.95	3.95	2.95	18	1.8	6
VPG06.150.203	1.5	20.3	6.2	-	5.95	3.95	2.95	23	1.8	6
VPG06.150.254	1.5	25.4	6.2	-	5.95	3.95	2.95	28	1.8	6
VPG06.150.102	1.5	30.5	6.2	-	5.95	3.95	2.95	33	1.8	6
VPG06.150.152	1.5	35.6	6.2	-	5.95	3.95	2.95	38	1.8	6

Sipariş Örneği/Ordering Example/Bestellbeispiel  
1 ad./pcs./stück VPG06.100.102

## MINI CUT GROOVING

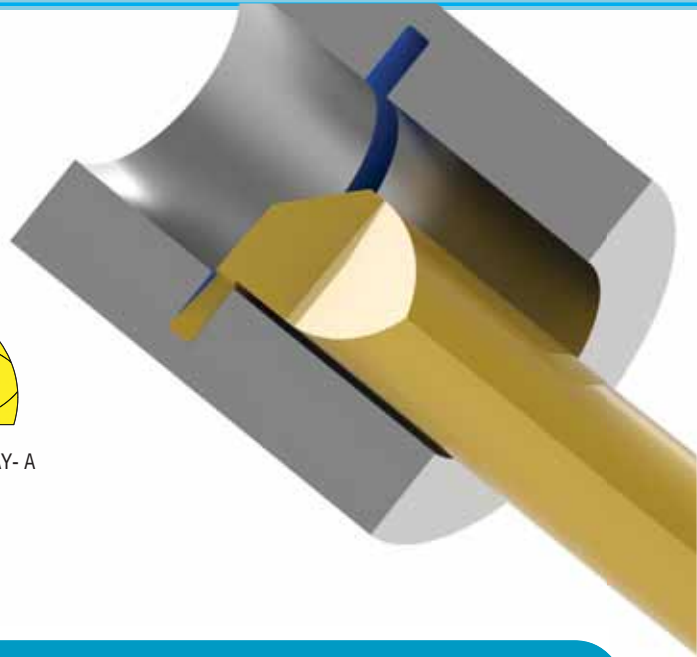
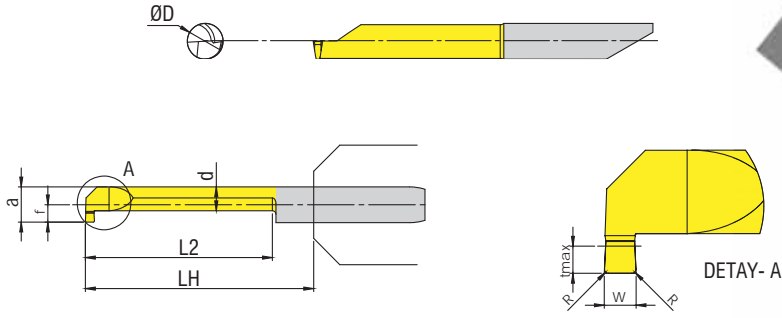

Ürün Kodu  
Product Code  
Artikelnummer

Takım Ölçüleri (mm)  
Dimension (mm)  
Abmessung (mm)

	W	L2	Ødmin	R	a	d	f	LH	tmax	ØD
VPG06.157.102	1.57	10,2	6,2	-	5.95	3.95	2.95	13	1.8	6
VPG06.157.152	1.57	15.2	6.2	-	5.95	3.95	2.95	18	1.8	6
VPG06.157.203	1.57	20.3	6.2	-	5.95	3.95	2.95	23	1.8	6
VPG06.157.254	1.57	25.4	6.2	-	5.95	3.95	2.95	28	1.8	6
VPG06.157.102	1.57	30.5	6.2	-	5.95	3.95	2.95	33	1.8	6
VPG06.157.152	1.57	35.6	6.2	-	5.95	3.95	2.95	38	1.8	6
VPG06.157.153	1.57	40,6	6.2	-	5.95	3.95	2.95	43	1.8	6
VPG06.198.102	1.98	10,2	6,2	-	5.95	3.95	2.95	13	1.8	6
VPG06.198.152	1.98	15.2	6.2	-	5.95	3.95	2.95	18	1.8	6
VPG06.198.203	1.98	20.3	6.2	-	5.95	3.95	2.95	23	1.8	6
VPG06.198.254	1.98	25.4	6.2	-	5.95	3.95	2.95	28	1.8	6
VPG06.198.102	1.98	30.5	6.2	-	5.95	3.95	2.95	33	1.8	6
VPG06.198.152	1.98	35.6	6.2	-	5.95	3.95	2.95	38	1.8	6
VPG06.198.153	1.98	40,6	6.2	-	5.95	3.95	2.95	43	1.8	6
VPG06.200.102	2,0	10,2	6,2	-	5.95	3.95	2.95	13	1.8	6
VPG06.200.152	2,0	15.2	6.2	-	5.95	3.95	2.95	18	1.8	6
VPG06.200.203	2,0	20.3	6.2	-	5.95	3.95	2.95	23	1.8	6
VPG06.200.254	2,0	25.4	6.2	-	5.95	3.95	2.95	28	1.8	6
VPG06.200.102	2,0	30.5	6.2	-	5.95	3.95	2.95	33	1.8	6
VPG06.200.152	2,0	35.6	6.2	-	5.95	3.95	2.95	38	1.8	6

Sipariş Örneği/Ordering Example/Bestellbeispiel  
1 ad./pcs./stück VPG06.157.102

## MINI CUT GROOVING

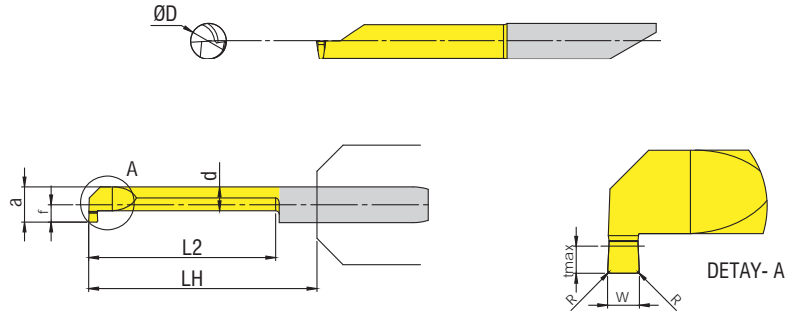

Ürün Kodu  
Product Code  
Artikelnummer

Takım Ölçüleri (mm)  
Dimension (mm)  
Abmessung (mm)

	W	L2	Ødmin	R	a	d	f	LH	tmax	ØD
VPG07.079.102	0,79	10,2	7.2	-	6.95	4.25	3.45	13	2.5	7
VPG07.079.152	0,79	15.2	7.2	-	6.95	4.25	3.45	18	2.5	7
VPG07.079.203	0,79	20.3	7.2	-	6.95	4.25	3.45	23	2.5	7
VPG07.079.254	0,79	25.4	7.2	-	6.95	4.25	3.45	28	2.5	7
VPG07.079.102	0,79	30.5	7.2	-	6.95	4.25	3.45	33	2.5	7
VPG07.079.152	0,79	35.6	7.2	-	6.95	4.25	3.45	38	2.5	7
VPG07.079.153	0,79	40,6	7.2	-	6.95	4.25	3.45	43	2.5	7
VPG07.100.102	1,0	10,2	7.2	-	6.95	4.25	3.45	13	2.5	7
VPG07.100.152	1,0	15.2	7.2	-	6.95	4.25	3.45	18	2.5	7
VPG07.100.203	1,0	20.3	7.2	-	6.95	4.25	3.45	23	2.5	7
VPG07.100.254	1,0	25.4	7.2	-	6.95	4.25	3.45	28	2.5	7
VPG07.100.102	1,0	30.5	7.2	-	6.95	4.25	3.45	33	2.5	7
VPG07.100.152	1,0	35.6	7.2	-	6.95	4.25	3.45	38	2.5	7
VPG07.100.153	1,0	40,6	7.2	-	6.95	4.25	3.45	43	2.5	7
VPG07.117.102	1.17	10,2	7.2	-	6.95	4.25	3.45	13	2.5	7
VPG07.117.152	1.17	15.2	7.2	-	6.95	4.25	3.45	18	2.5	7
VPG07.117.203	1.17	20.3	7.2	-	6.95	4.25	3.45	23	2.5	7
VPG07.117.254	1.17	25.4	7.2	-	6.95	4.25	3.45	28	2.5	7
VPG07.117.102	1.17	30.5	7.2	-	6.95	4.25	3.45	33	2.5	7
VPG07.117.152	1.17	35.6	7.2	-	6.95	4.25	3.45	38	2.5	7
VPG07.117.153	1.17	40,6	7.2	-	6.95	4.25	3.45	43	2.5	7

Sipariş Örneği/Ordering Example/Bestellbeispiel  
1 ad./pcs./stück VPG07.079.102

## MINI CUT GROOVING

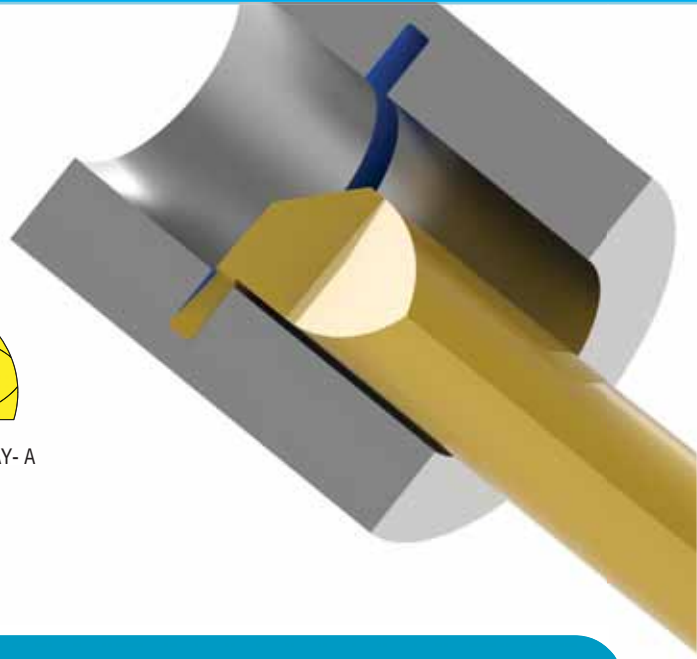
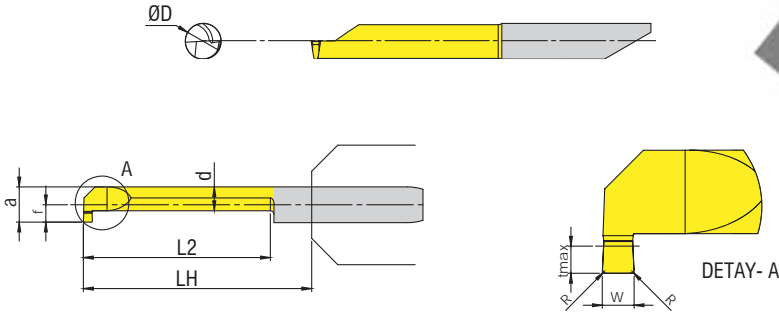

Ürün Kodu  
Product Code  
Artikelnummer

Takım Ölçüleri (mm)  
Dimension (mm)  
Abmessung (mm)

	W	L2	Ødmin	R	a	d	f	LH	tmax	ØD
VPG07.117.102	1.5	10,2	7.2	-	6.95	4.25	3.45	13	2.5	7
VPG07.117.152	1.5	15.2	7.2	-	6.95	4.25	3.45	18	2.5	7
VPG07.117.203	1.5	20.3	7.2	-	6.95	4.25	3.45	23	2.5	7
VPG07.117.254	1.5	25.4	7.2	-	6.95	4.25	3.45	28	2.5	7
VPG07.117.102	1.5	30.5	7.2	-	6.95	4.25	3.45	33	2.5	7
VPG07.117.152	1.5	35.6	7.2	-	6.95	4.25	3.45	38	2.5	7
VPG07.117.153	1.5	40,6	7.2	-	6.95	4.25	3.45	43	2.5	7
VPG07.157.102	1.57	10,2	7.2	-	6.95	4.25	3.45	13	2.5	7
VPG07.157.152	1.57	15.2	7.2	-	6.95	4.25	3.45	18	2.5	7
VPG07.157.203	1.57	20.3	7.2	-	6.95	4.25	3.45	23	2.5	7
VPG07.157.254	1.57	25.4	7.2	-	6.95	4.25	3.45	28	2.5	7
VPG07.157.102	1.57	30.5	7.2	-	6.95	4.25	3.45	33	2.5	7
VPG07.157.152	1.57	35.6	7.2	-	6.95	4.25	3.45	38	2.5	7
VPG07.157.153	1.57	40,6	7.2	-	6.95	4.25	3.45	43	2.5	7
VPG07.198.102	1.98	10,2	7.2	-	6.95	4.25	3.45	13	2.5	7
VPG07.198.152	1.98	15.2	7.2	-	6.95	4.25	3.45	18	2.5	7
VPG07.198.203	1.98	20.3	7.2	-	6.95	4.25	3.45	23	2.5	7
VPG07.198.254	1.98	25.4	7.2	-	6.95	4.25	3.45	28	2.5	7
VPG07.198.102	1.98	30.5	7.2	-	6.95	4.25	3.45	33	2.5	7
VPG07.198.152	1.98	35.6	7.2	-	6.95	4.25	3.45	38	2.5	7

Sipariş Örneği/Ordering Example/Bestellbeispiel  
1 ad./pcs./stück VPG07.117.102

## MINI CUT GROOVING

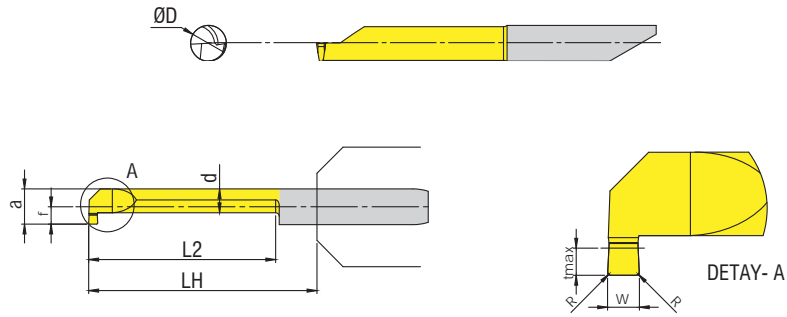

Ürün Kodu  
Product Code  
Artikelnummer

Takım Ölçüleri (mm)  
Dimension (mm)  
Abmessung (mm)

	W	L2	Ødmin	R	a	d	f	LH	tmax	ØD
VPG07.200.102	2,0	10,2	7.2	-	6.95	4.25	3.45	13	2.5	7
VPG07.200.152	2,0	15.2	7.2	-	6.95	4.25	3.45	18	2.5	7
VPG07.200.203	2,0	20.3	7.2	-	6.95	4.25	3.45	23	2.5	7
VPG07.200.254	2,0	25.4	7.2	-	6.95	4.25	3.45	28	2.5	7
VPG07.200.102	2,0	30.5	7.2	-	6.95	4.25	3.45	33	2.5	7
VPG07.200.152	2,0	35.6	7.2	-	6.95	4.25	3.45	38	2.5	7
VPG10.100.305	1,0	30.5	10.5	-	9.95	5.45	4.95	33,0	4,0	10
VPG10.100.508	1,0	50,8	10.5	-	9.95	5.45	4.95	53,0	4,0	10
VPG10.200.305	2,0	30.5	10.5	-	9.95	5.45	4.95	33,0	4,0	10
VPG10.200.508	2,0	50,8	10.5	-	9.95	5.45	4.95	53,0	4,0	10
VPG10.300.305	3,0	30.5	10.5	-	9.95	5.45	4.95	33,0	4,0	10
VPG10.300.508	3,0	50,8	10.5	-	9.95	5.45	4.95	53,0	4,0	10

Sipariş Örneği/Ordering Example/Bestellbeispiel  
1 ad./pcs./stück VPG07.200.102

## MINI CUT GROOVING

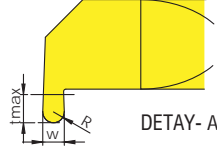
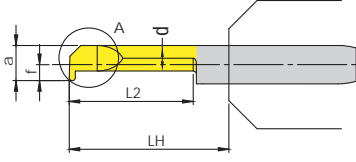
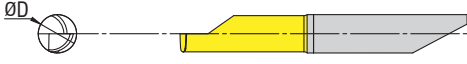

Ürün Kodu  
Product Code  
Artikelnummer

Takım Ölçüleri (mm)  
Dimension (mm)  
Abmessung (mm)

	W	L2	Ødmin	R	a	d	f	LH	tmax	ØD
VPG04.100.152.R050	1,0	15,2	4,2	0,5	3,95	2,95	1,95	18,0	0,8	4
VPG04.117.152.R0585	1,17	15,2	4,2	0,585	3,95	2,95	1,95	18,0	0,8	4
VPG05.100.203.R050	1,0	20,3	5,2	0,5	4,95	3,75	2,45	23,0	1,0	5
VPG05.117.203.R0585	1,17	20,3	5,2	0,585	4,95	3,75	2,45	23,0	1,0	5
VPG05.150.203.R075	1,5	20,3	5,2	0,75	4,95	3,75	2,45	23,0	1,0	5
VPG05.1574.203.R0787	1,574	20,3	5,2	0,787	4,95	3,75	2,45	23,0	1,0	5
VPG05.1626.203.R0813	1,626	20,3	5,2	0,813	4,95	3,75	2,45	23,0	1,0	5
VPG05.198.203.R099	1,98	20,3	5,2	0,99	4,95	3,75	2,45	23,0	1,0	5
VPG05.200.203.R100	2,0	20,3	5,2	1,0	4,95	3,75	2,45	23,0	1,0	5
VPG06.100.254.R050	1,0	25,4	6,2	0,5	5,95	3,95	2,95	28,0	1,8	6
VPG06.117.254.R0585	1,17	25,4	6,2	0,585	5,95	3,95	2,95	28,0	1,8	6
VPG06.150.254.R075	1,5	25,4	6,2	0,75	5,95	3,95	2,95	28,0	1,8	6
VPG06.1574.254.R0787	1,574	25,4	6,2	0,787	5,95	3,95	2,95	28,0	1,8	6
VPG06.1626.254.R0813	1,626	25,4	6,2	0,813	5,95	3,95	2,95	28,0	1,8	6
VPG06.198.254.R099	1,98	25,4	6,2	0,99	5,95	3,95	2,95	28,0	1,8	6
VPG06.200.203.R100	2,0	20,3	6,2	1,0	5,95	3,95	2,95	23,0	1,8	6
VPG06.200.254.R100	2,0	25,4	6,2	1,0	5,95	3,95	2,95	28,0	1,8	6
VPG07.100.305.R050	1,0	30,5	7,2	0,5	6,95	4,25	3,45	33,0	2,5	7
VPG07.117.305.R0585	1,17	30,5	7,2	0,585	6,95	4,25	3,45	33,0	2,5	7
VPG07.150.305.R075	1,5	30,5	7,2	0,75	6,95	4,25	3,45	33,0	2,5	7
VPG07.1574.305.R0787	1,574	30,5	7,2	0,787	6,95	4,25	3,45	33,0	2,5	7
VPG07.1626.305.R0813	1,626	30,5	7,2	0,813	6,95	4,25	3,45	33,0	2,5	7
VPG07.198.305.R099	1,98	30,5	7,2	0,99	6,95	4,25	3,45	33,0	2,5	7
VPG07.200.305.R100	2,0	30,5	7,2	1,0	6,95	4,25	3,45	33,0	2,5	7

Sipariş Örneği/Ordering Example/Bestellbeispiel  
1 ad./pcs./stück VPG04.100.152.R050



## MINI CUT THREADING

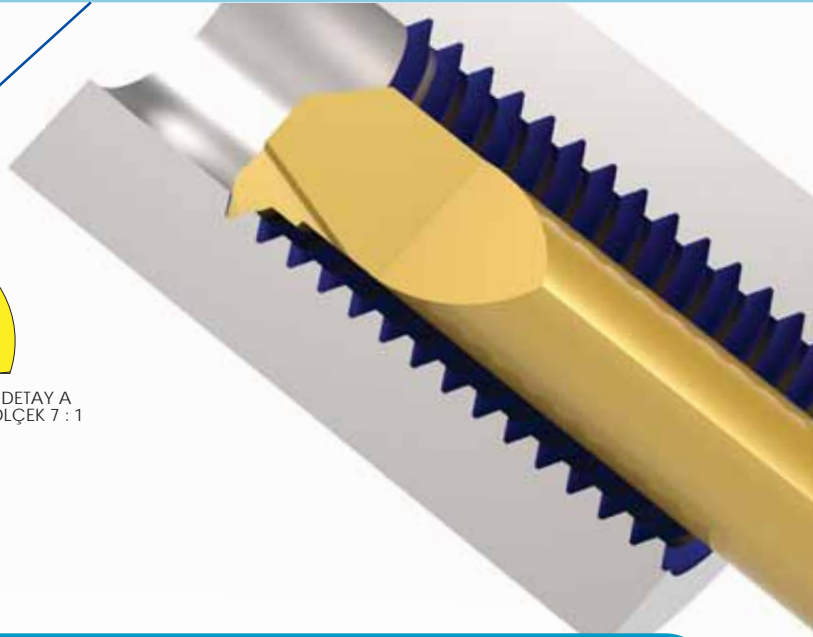
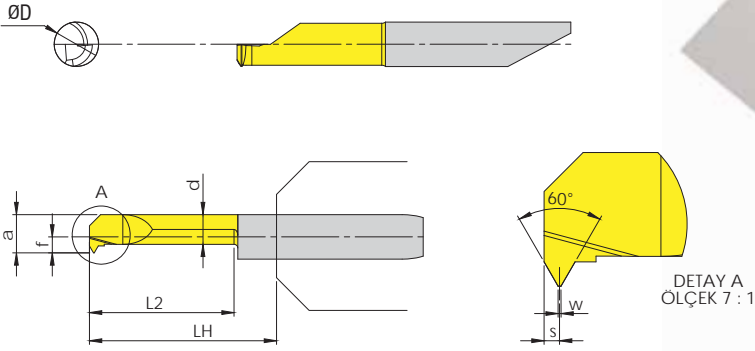

Ürün Kodu  
Product Code  
Artikelnummer

Takım Ölçüleri (mm)  
Dimension (mm)  
Abmessung (mm)

	PITCH		L2	ØDmin	a	d	f	LH	S	t	w	ØD
	maks	min										
VPT.04.152.080	0,8	1,0	15,2	3,9	3,65	2,7	1,95	18,0	0,45	0,46	0,1	4
VPT.04.152.050	0,5	0,7	15,2	4,2	3,95	2,95	1,95	18,0	0,35	0,4	0,06	4
VPT.05.152.100	1,0	1,25	15,2	4,8	4,55	3,55	2,25	18,0	0,55	0,7	0,12	5
VPT.05.203.100	1,0	1,25	20,3	4,8	4,55	3,55	2,25	23,0	0,55	0,7	0,12	5
VPT.05.254.100	1,0	1,25	25,4	4,8	4,55	3,55	2,25	28,0	0,55	0,7	0,12	5
VPT.05.152.075	0,75	1,0	15,2	5,1	4,85	3,65	2,40	18,0	0,45	0,57	0,09	5
VPT.05.152.050	0,5	0,75	15,2	5,2	4,95	3,75	2,45	18,0	0,35	0,43	0,06	5
VPT.06.152.125	1,0	1,25	15,2	6,2	5,95	3,95	2,95	18,0	0,55	0,7	0,12	6
VPT.06.152.150	1,25	1,5	15,2	6,2	5,95	3,95	2,95	18,0	0,75	0,84	0,16	6
VPT.06.203.125	1,25	1,5	20,3	6,2	5,95	3,95	2,95	23,0	0,75	0,84	0,16	6
VPT.06.254.125	1,25	1,5	25,4	6,2	5,95	3,95	2,95	28,0	0,75	0,84	0,16	6
VPT.06.152.175	1,5	1,75	15,2	6,2	5,95	3,95	2,95	18,0	0,8	0,98	0,18	6
VPT.06.203.175	1,5	1,75	20,3	6,2	5,95	3,95	2,95	23,0	0,8	0,98	0,18	6
VPT.06.254.175	1,5	1,75	25,4	6,2	5,95	3,95	2,95	28,0	0,8	0,98	0,18	6

Sipariş Örneği/Ordering Example/Bestellbeispiel  
1 ad./pcs./stück VPT.04.152.080

## MINI CUT FACE GROOVING

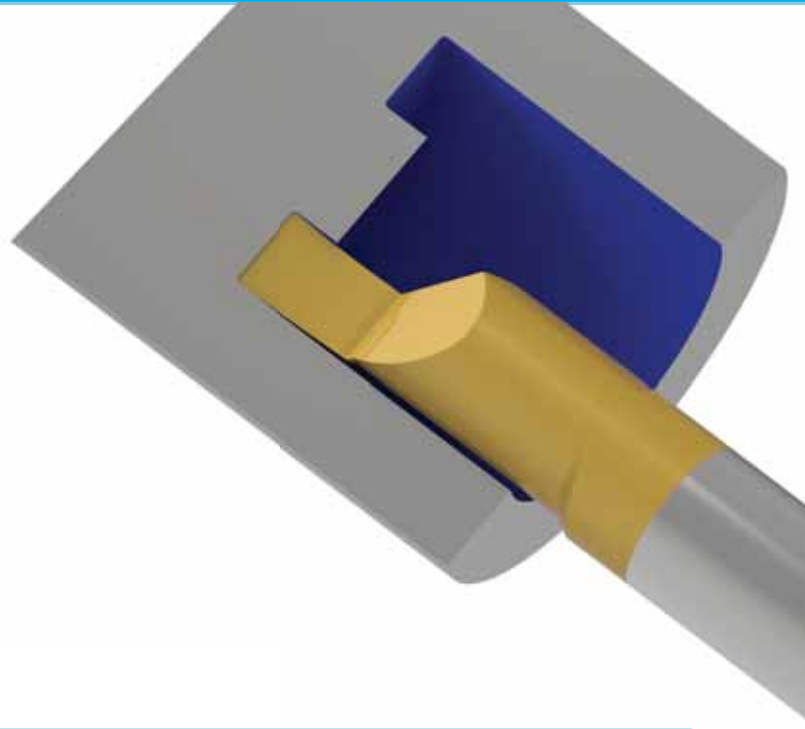
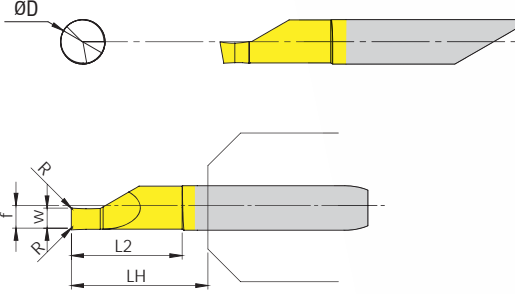

Ürün Kodu  
Product Code  
Artikelnummer

Takım Ölçüleri (mm)  
Dimension (mm)  
Abmessung (mm)

	W	L2	R	f	LH	tmax	ØD
VPPG.06.152.0787	0,787	15,2	0,05	2,95	18,0	1,8	6
VPPG.06.152.1000	1,0	15,2	0,05	2,95	18,0	2,0	6
VPPG.06.152.1500	1,5	15,2	0,05	2,95	18,0	3,0	6
VPPG.06.152.1000	1,0	15,2	0,15	2,95	18,0	2,0	6
VPPG.06.152.1168	1,168	15,2	0,15	2,95	18,0	2,34	6
VPPG.06.152.1500	1,5	15,2	0,15	2,95	18,0	3,0	6
VPPG.06.152.1575	1,575	15,2	0,15	2,95	18,0	3,15	6
VPPG.06.152.1981	1,981	15,2	0,15	2,95	18,0	3,95	6
VPPG.06.152.2000	2,0	15,2	0,15	2,95	18,0	4,0	6
VPPG.06.152.2388	2,388	15,2	0,15	2,95	18,0	5,0	6
VPPG.06.152.2500	2,5	15,2	0,15	2,95	18,0	5,0	6
VPPG.06.152.3000	3,0	15,2	0,15	2,95	18,0	6,0	6
VPPG.06.152.3175	3,175	15,2	0,15	2,95	18,0	6,0	6



# SPECIAL MINI CUT TOOLS

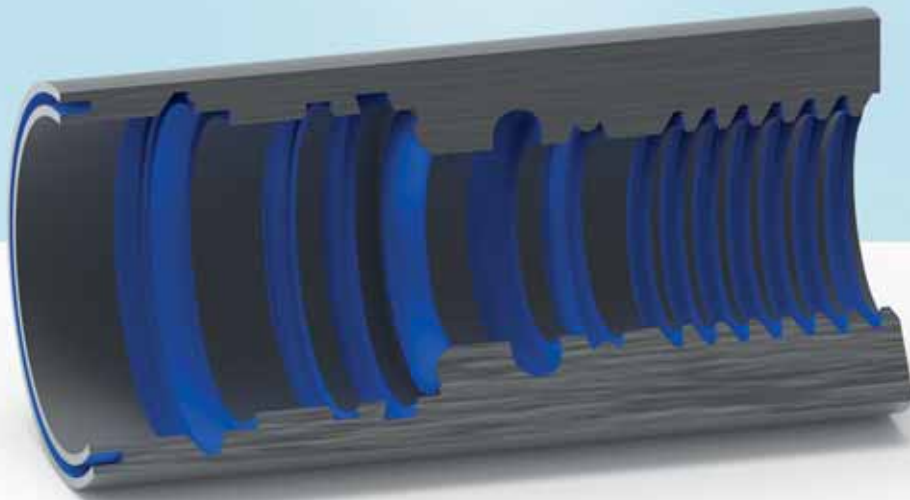

**MINI CUT TAKIMLARI BİLGİ ALMA FORMU**  
*INFORMATION REQUEST FORM FOR MINI CUT TOOLS*  
*INFORMATIONSFÖRMULAR FÜR MINI CUT WERKZEUGE*

TOOL TYPE		TOOL DIMENSIONS				
		ØD	ØDmin	L	RE	TMAX
BORING	<input type="checkbox"/>					
GROOVING	<input type="checkbox"/>				RE - R1,R2	W TMAX
FACE GROOVING	<input type="checkbox"/>				RE - R1,R2	W TMAX
THREADING	<input type="checkbox"/>	CHOOSE THREADING TYPE				
		METRIC <input type="checkbox"/>		NPT <input type="checkbox"/>		UNF/UNC <input type="checkbox"/>
		TRAPEZOIDAL <input type="checkbox"/>		WHITWORTH <input type="checkbox"/>	ACME <input type="checkbox"/>	

# TORX - ALYAN / PUNCH - KAZIMA TAKIMLARI

TORX-ALLEN / PUNCH - BROACH SET

*TORX WINKELSCHRAUBENDEHER WERKZEUGE*



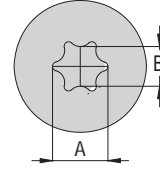
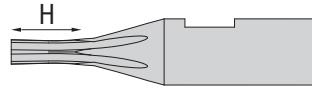

Ürün Kodu  
 Product Code  
 Artikelnummer

Soket Numarası  
 Socket Number  
 Seriennummer

Uç Ölçüleri (mm)  
 Insert Dimension (mm)  
 Abmessung (mm)

Ürün Kodu Product Code Artikelnummer	Soket Numarası Socket Number Seriennummer	Uç Ölçüleri (mm) Insert Dimension (mm) Abmessung (mm)			
		ØD	H	A	B
VPTX-006	6	4	1.82	1.75	1.27
VPTX-008	8	4	3.05	2.4	1.75
VPTX-010	10	4	3.56	2.8	2.05
VPTX-015	15	4	3.81	3.35	2.4
VPTX-020	20	5	4.07	3.95	2.85
VPTX-025	25	5	4.45	4.5	3.25
VPTX-030	30	7	4.95	5.6	4.05
VPTX-040	40	7	5.59	6.75	4.85
VPTX-045	45	9	6.22	7.93	5.64
VPTX-050	50	10	6.48	8.95	6.45



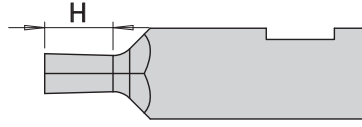

Ürün Kodu  
Product Code  
Artikelnummer

Soket Numarası  
Socket Number  
Serienummer

Uç Ölçüleri (mm)  
Insert Dimension (mm)  
Abmessung (mm)

ØD

H

VPHX-0016  
VPHX-0020  
VPHX-0025  
VPHX-0030  
VPHX-0035  
VPHX-0040  
VPHX-0045  
VPHX-0050  
VPHX-0060  
VPHX-0080  
VPHX-0100  
VPHX-0120  
VPHX-0140  
VPHX-0160  
VPHX-0200

M1,6  
M2,0  
M2,5  
M3,0  
M3,5  
M4,0  
M4,5  
M5,0  
M6,0  
M8,0  
M10  
M12  
M14  
M16  
M20

4  
4  
4  
4  
4  
4  
5  
5  
6  
7  
10  
12  
14  
17  
21

3  
4  
5  
6  
6  
8  
9  
10  
11  
12  
12  
12  
16  
18  
20

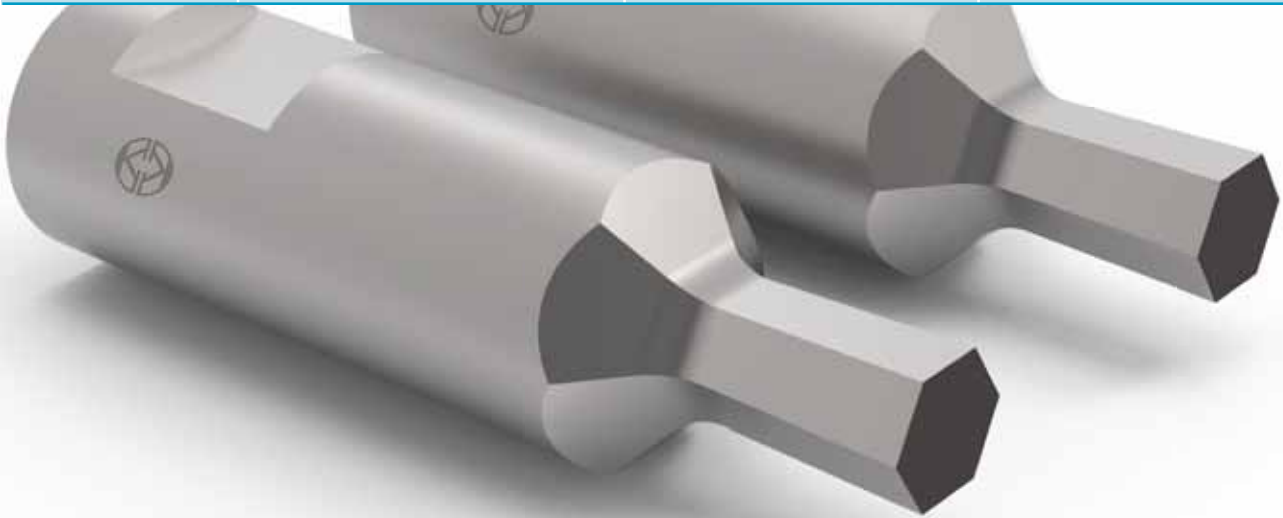

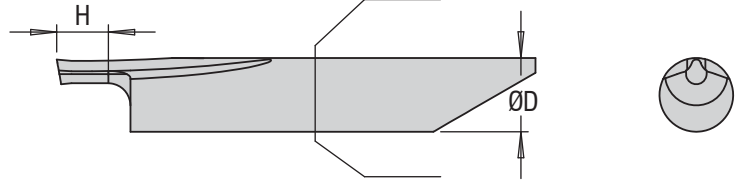

Ürün Kodu Product Code Artikelnummer	Soket Numarası Socket Number Seriennummer	Uç Ölçüleri (mm) Insert Dimension (mm) Abmessung (mm)	
		ØD	L2
VKTX-006	6	6	3,0
VKTX-008	8	6	4,0
VKTX-010	10	6	4,5
VKTX-015	15	6	4,5
VKTX-020	20	6	5,0
VKTX-030	30	6	6,0
VKTX-040	40	6	6,5
VKTX-045	45	6	7,0

Ürün Kodu Product Code Artikelnummer	Soket Numarası Socket Number Seriennummer	Uç Ölçüleri (mm) Insert Dimension (mm) Abmessung (mm)	
		ØD	L2
VKTX-050	50	6	7,0
VKTX-055	55	6	7,5
VKTX-060	60	6	9,0
VKTX-070	70	6	9,5
VKTX-080	80	6	10,5
VKTX-090	90	6	11,5
VKTX-100	100	6	12,0

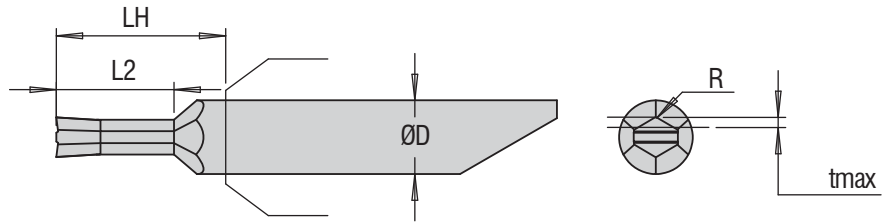

Ürün Kodu Product Code Artikelnummer	Soket Numarası Socket Number Seriennummer	Uç Ölçüleri (mm) Insert Dimension (mm) Abmessung (mm)				
		ØD	r	L2	LH	Tmax
VKHX-001-001	1	3	0,05	2	4	0,3
VKHX-002-002	2	3	0,05	3	5	0,6
VKHX-003-003	3	4	0,05	6	8	1
VKHX-004-006	4-6	5	0,10	8	10	1
VKHX-007-012	7-12	6	0,15	12	15	1,5
VKHX-013-018	13-18	9	0,20	15	17	2

COMING  
SOON!



NEW!  
S-DRILL







 **AKKO**<sup>®</sup>

[www.akkocom.tr](http://www.akkocom.tr)

# DİŞ AÇMA FREZELEME TAKIMLARI VE UÇLARI

THREAD MILLING INSERTS AND TOOLHOLDER  
GEWINDEFÄSERWERKZEUGE



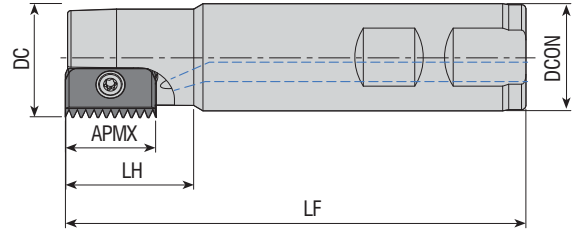

Takım Kodu Ordering Code Bestell-Bezeichnung	Stok Stock Lager	Takım Ölçüleri (mm) Dimension (mm) Abmessung (mm)						Kesici Uç Insert Wendeschneidplatte	Yedek Parçaları / Spare Parts / Ersatzteile		
		DC	ZEFP	DCON	LF	LH	APMX		Sıkma Vidası Screw Schraube	Tork Anahtar Torx Key Torx-Schlüssel	
ATM-C14-D14-W20-L100-Z01-H	●	14	1	20	100	25	14	C14	3008-M2.5x6	82-T08	
ATM-C21-D18-W20-L100-Z01-H	●	18	1	20	100	30	21		4015-M4x9		
ATM-C21-D21-W25-L125-Z01-H	●	21	1	25	125	40	21		C21	4015-M4x11	80-T15
ATM-C21-D25-W20-L125-Z01-H	●	25	1	20	125	30	21				
ATM-C21-D28-W25-L90-Z01-H	●	28	1	25	90	30	21				
ATM-C21-D38-W32-L90-Z03-H	●	38	3	32	90	30	21				
ATM-C21-D38-W32-L120-Z03-H	●	38	3	32	120	30	21				
ATM-C21-D43-W32-L90-Z03-H	●	43	3	32	90	30	21	C30	1020-M5x14	80-T20	
ATM-C30-D29-W25-L150-Z01-H	●	29	1	25	150	50	30				

CPT Ucuna Uygundur. / Compatible with CPT Insert. / Kompatibel mit CPT Wendeplatten.

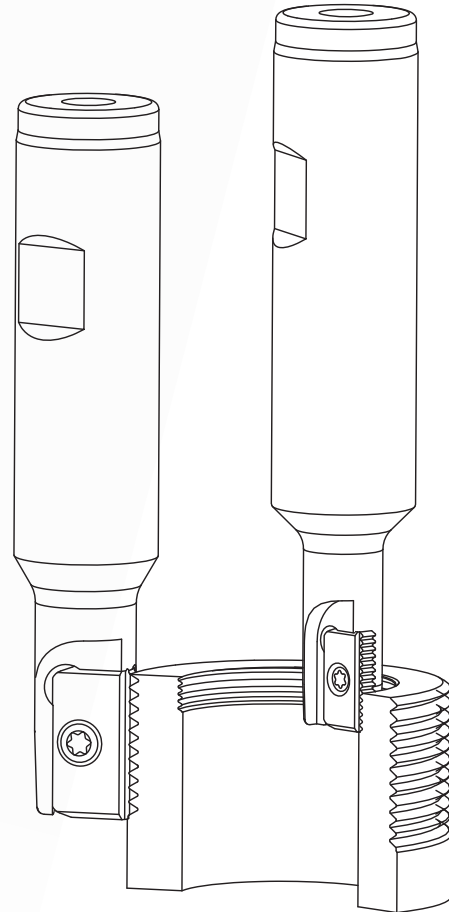

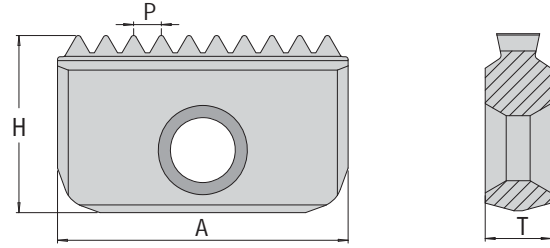
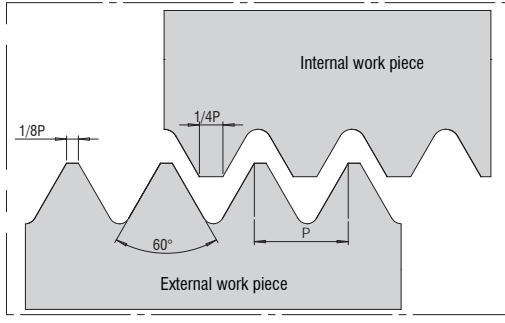

Ürün Kodu Product Code Artikelnummer	Insert Tipi Insert Type Wendeplatten Typ A	Takım Ölçüleri (mm) Dimension (mm) Abmessung (mm)		
		Adım Pitch Wendeplatten Typ	H	T
VDTI.14.050	C14	0.5	7.5	3.1
VDTI.14.075		0.75	7.5	3.1
VDTE.14.075		0.75	7.5	3.1
VDTI.14.100		1.00	7.5	3.1
VDTE.14.100		1.00	7.5	3.1
VDTI.14.125		1.25	7.5	3.1
VDTE.14.125		1.25	7.5	3.1
VDTI.14.150		1.50	7.5	3.1
VDTE.14.150		1.50	7.5	3.1
VDTI.14.175		1.75	7.5	3.1
VDTE.14.175		1.75	7.5	3.1
VDTI.14.200		2.00	7.5	3.1
VDTE.14.200		2.00	7.5	3.1
VDTI.14.250		2.50	7.5	3.1
VDTE.14.250		2.50	7.5	3.1

Ürün Kodu Product Code Artikelnummer	Insert Tipi Insert Type Wendeplatten Typ A	Takım Ölçüleri (mm) Dimension (mm) Abmessung (mm)		
		Adım Pitch Wendeplatten Typ	H	T
VDTI.21.100	C21	1.00	12	4.7
VDTE.21.100		1.00	12	4.7
VDTI.21.150		1.50	12	4.7
VDTE.21.150		1.50	12	4.7
VDTI.21.175		1.75	12	4.7
VDTI.21.200		2.00	12	4.7
VDTE.21.200		2.00	12	4.7
VDTI.21.250		2.50	12	4.7
VDTE.21.250		2.50	12	4.7
VDTI.21.300		3.00	12	4.7
VDTE.21.300		3.00	12	4.7
VDTI.21.350		3.5	12	4.7



# SPECIAL THREADING MILLING TOOLS

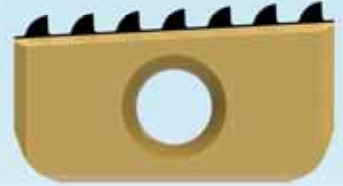
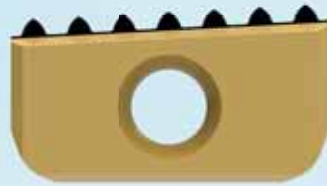
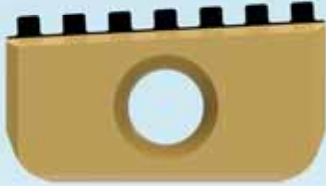

## DİŞ TARAĞI BİLGİ ALMA FORMU

INFORMATION FORM FOR SPECIAL THREAD MILLING INSERTS  
INFORMATIONSFÖRM FÜR SONDER GEWINDEFÄRÄSERWERKZEUGE

Insert Type	Thread Type	Thread Pitch mm	Thread Profile
C 14	External <input type="checkbox"/> Internal <input type="checkbox"/> Nötr <input type="checkbox"/>		ISO <input type="checkbox"/> UN <input type="checkbox"/> WHIT <input type="checkbox"/> NPT <input type="checkbox"/> NPTF <input type="checkbox"/> BSPT <input type="checkbox"/> NPS <input type="checkbox"/> NPSF <input type="checkbox"/> PG <input type="checkbox"/>
C 21	External <input type="checkbox"/> Internal <input type="checkbox"/> Nötr <input type="checkbox"/>		ISO <input type="checkbox"/> UN <input type="checkbox"/> WHIT <input type="checkbox"/> NPT <input type="checkbox"/> NPTF <input type="checkbox"/> BSPT <input type="checkbox"/> NPS <input type="checkbox"/> NPSF <input type="checkbox"/> PG <input type="checkbox"/>

# SEGMAN UÇLARI VE TAKIMLARI

RING INSERTS AND TOOLHOLDERS  
*RINGEINSÄTZE UND WERKZEUGHALTER*



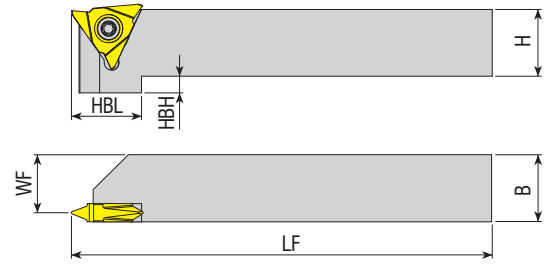

Takım Kodu Ordering Code Bestell-Bezeichnung	Stok Stock Lager		Takım Ölçüleri (mm) Dimension (mm) Abmessung (mm)					Kesici Uç Insert Wendeschneidplatte	Yedek Parçaları / Spare Parts / Ersatzteile		
	R	L	H	B	WF	LF	HBL		HBH	Sıkma Vidası Screw Schraube	Tork Anahtar Torx Key Torx-Schlüssel
ADKT-T12P-R/L-1616-T5	●	●	16	16	13.50	125	21	5			
ADKT-T12P-R/L-2020-T5	●	●	20	20	17.50	125	21	5	T12...	1020-M5x14	80-T20
ADKT-T12P-R/L-2525-T5	●	●	25	25	22.50	150	-	-			
ADKT-T12P-R/L-3232-T5	●	●	32	32	29.50	170	-	-			

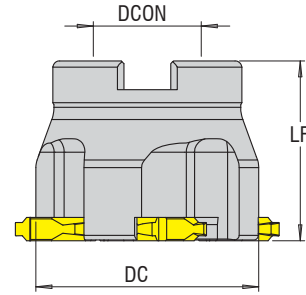

Takım Kodu Ordering Code Bestell-Bezeichnung	Takım Ölçüleri (mm) Dimension (mm) Abmessung (mm)					Kesici Uç Insert Wendeschneidplatte	Yedek Parçaları / Spare Parts / Ersatzteile	
	DC	ZEFP	DCON	LF	APMX		Sıkma Vidası Screw Schraube	Tork Anahtar Torx Key Torx-Schlüssel
ASFM-T12-D40x5.2-A22-Z04	40	2	16	40	-			
ASFM-T12-D50x5.2-A22-Z04	50	3	22	40	-	T12...	1020-M5x14	80-T20
ASFM-T12-D60x5.2-A22-Z04	60	4	22	40	-			

Sipariş Örneği/Ordering Example/Bestellbeispiel  
1 ad./pcs./stück ADKT-T12P-R/L-1616-T5

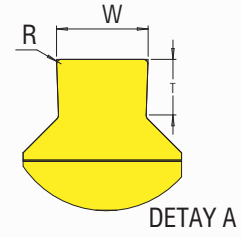
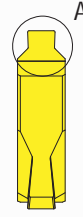
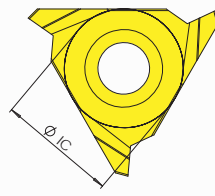

DETAY A

Ürün Kodu Product Code Artikelnummer	Stok Stock Lager	Uç Ölçüleri (mm) Insert Dimension (mm) Abmessung (mm)			
		IC	W	R	T
VSK-125-13	●	13	1.25	0.2	1.3
VSK-135-13	●	13	1.35	0.2	1.3
VSK-145-13	●	13	1.45	0.2	1.3
VSK-150-13	●	13	1.5	0.2	1.3
VSK-165-18	●	13	1.65	0.2	1.8
VSK-175-18	●	13	1.75	0.2	1.8
VSK-185-23	●	13	1.85	0.2	2.3
VSK-200-23	●	13	2	0.2	2.3
VSK-220-33	●	13	2.2	0.2	3.3
VSK-230-33	●	13	2.3	0.2	3.3
VSK-250-33	●	13	2.5	0.3	3.3
VSK-265-33	●	13	2.65	0.3	3.3
VSK-270-33	●	13	2.7	0.3	3.3
VSK-280-33	●	13	2.8	0.3	3.3
VSK-300-33	●	13	3	0.3	3.3
VSK-320-33	●	13	3.2	0.3	3.3
VSK-330-33	●	13	3.3	0.3	3.3
VSK-350-38	●	13	3.5	0.3	3.8
VSK-370-38	●	13	3.7	0.3	3.8
VSK-390-38	●	13	3.9	0.3	3.8
VSK-400-38	●	13	4	0.3	3.8

● Stokta / In Stock / Auf Lager ○ Stokta Yok / Non Stock Item / Kein Lagerartikel, Lieferzeit auf Anfrage

Sipariş Örneği/Ordering Example/Bestellbeispiel  
1 ad./pcs./stück ADKT-T12P-R/L-1616-T5





**SEGMAN UCU BİLGİ ALMA FORMU**

*INFORMATION REQUEST FORM FOR RING INSERTS  
INFORMATIONSFÖRMULAR FÜR RINGEINSÄTZE*

<b>W :</b>		
<b>R :</b>		
<b>R1 :</b>		
<b><math>\beta</math> :</b>		



**AKKO**

*Cözümleri*  
**SOLUTIONS**  
Lösungen



**ÖZEL FORM KANAL AÇMA ÇÖZÜMÜ**  
**SPECIAL FORM GROOVING SOLUTIONS**  
**LÖSUNGEN ZUM EINSTECHDREHEN IN SONDERFORMEN**

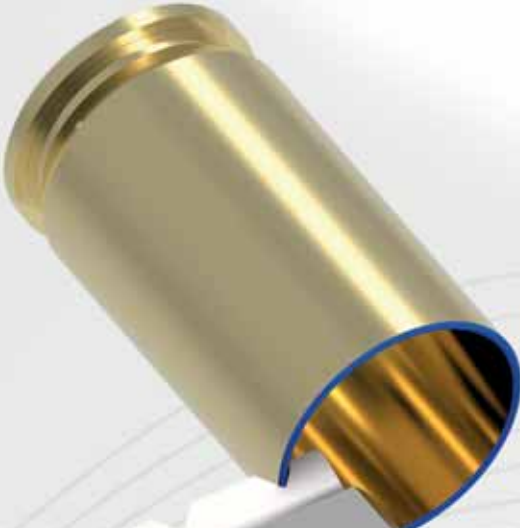
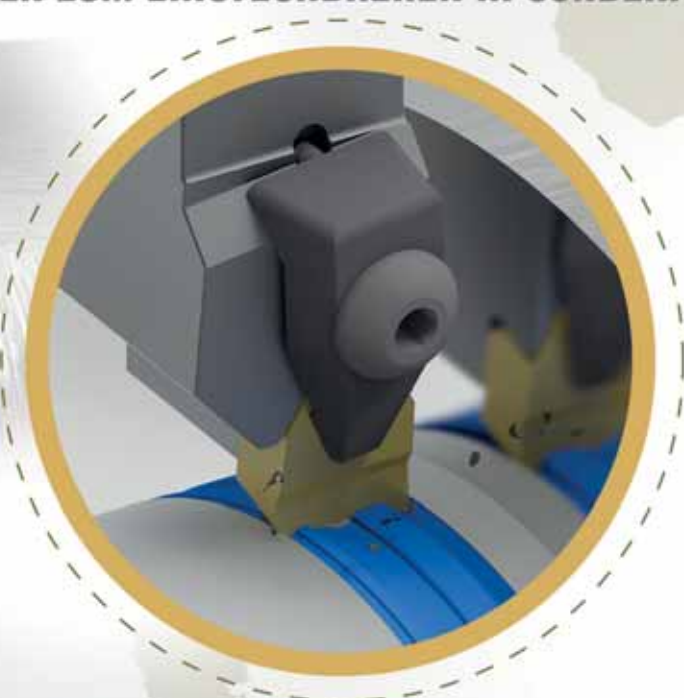
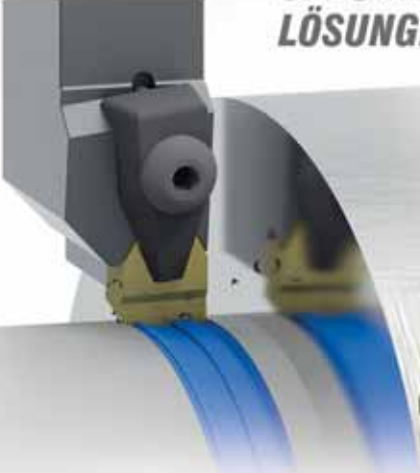

**ÖZEL TALAŞLI İMALAT ÇÖZÜMLERİ**  
**SPECIAL MACHINING SOLUTIONS**  
**SONDERLÖSUNGEN FÜR MASCHINEN**

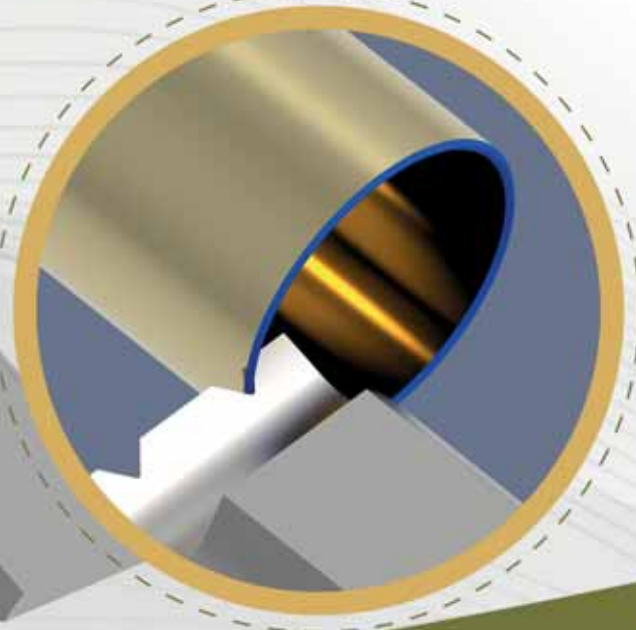



**ÖZEL FORM KANAL AÇMA ÇÖZÜMÜ**  
**SPECIAL FORM GROOVING SOLUTIONS**  
**LÖSUNGEN ZUM EINSTECHDREHEN IN SONDERFORMEN**

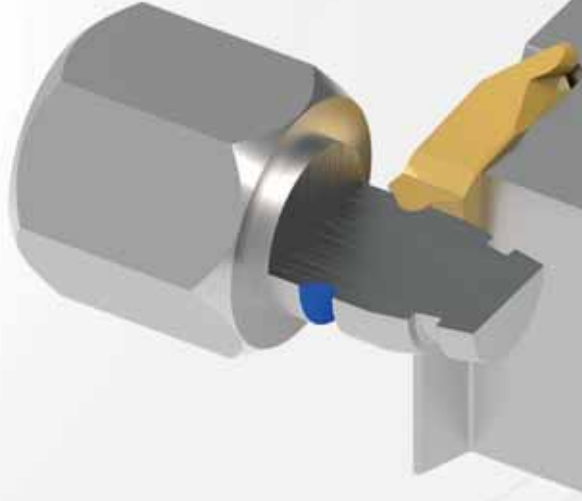



**ÖZEL FORM KANAL AÇMA ÇÖZÜMÜ**  
**SPECIAL FORM GROOVING SOLUTIONS**  
**LÖSUNGEN ZUM EINSTECHDREHEN IN SONDERFORMEN**

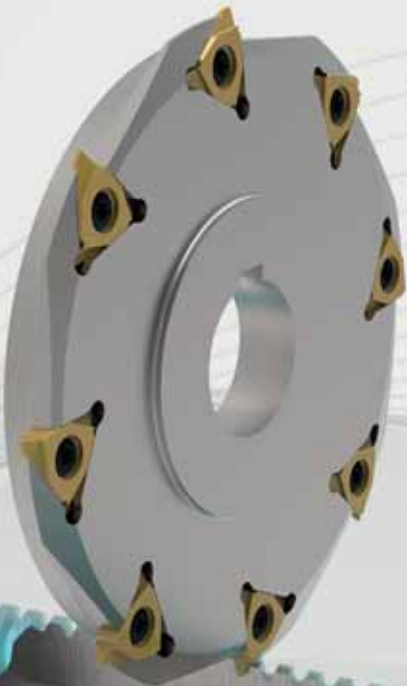
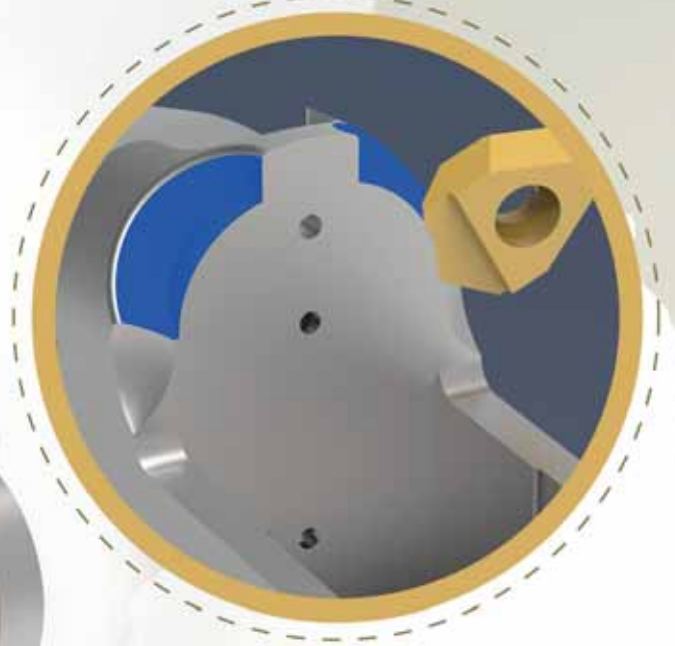
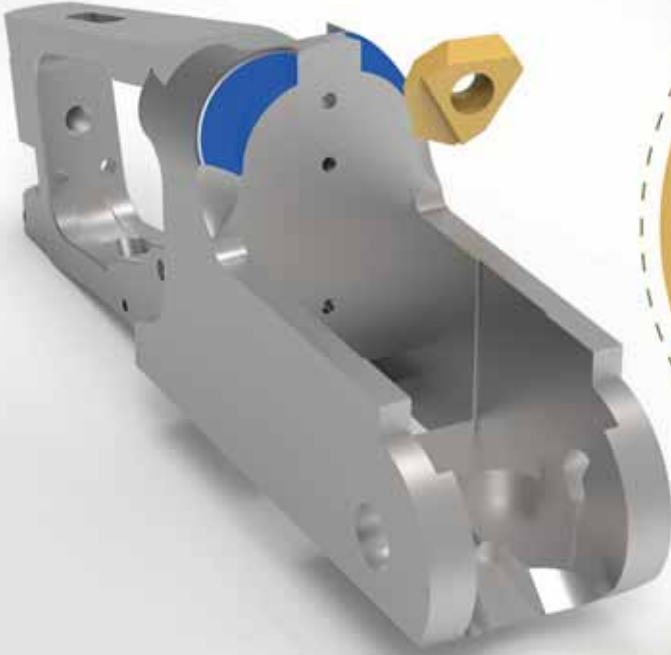

**SONSUZ DIŞLİ FREZELEME ÇÖZÜMLERİ**  
**SPECIAL MACHINING SOLUTIONS**  
**LÖSUNGEN ZUM FRÄSEN MIT**  
**ZAHNSTANGENGETRIEBE**



**ÖZEL FORM FREZELEME ÇÖZÜMLERİ**  
**SPECIAL FORM MILLING SOLUTIONS**  
**LÖSUNGEN FÜR SONDERFORMEN**  
**ZUM FRÄSEN**



**ÖZEL SUPAP ÇÖZÜMLERİ**  
**SPECIAL VALVE SOLUTIONS**  
**SPEZIELLE VENTILLÖSUNGEN**





**HELİSEL ÖZEL FORM AÇMA ÇÖZÜMLERİ**  
**HELICAL SPECIAL FORMING SOLUTIONS**  
**HELIX SONDERFORMEBEARBEITUNGSLÖSUNGEN**



**ÖZEL TAKIMLANDIRMA ÇÖZÜMLERİ**  
**SPECIAL MACHINING SOLUTIONS**  
**SONDERLÖSUNGEN FÜR**  
**WERKZEUGHALTER**





**PETROL SONDAJ BORULARI DIŐ ÇEKME ÇÖZÜMLERİ**  
**SPECIAL FORM MILLING SOLUTIONS**  
**LÖSUNGEN MIT EINFÄDELWERKZEUG**  
**FÜR ÖL-GAS ROHREN**

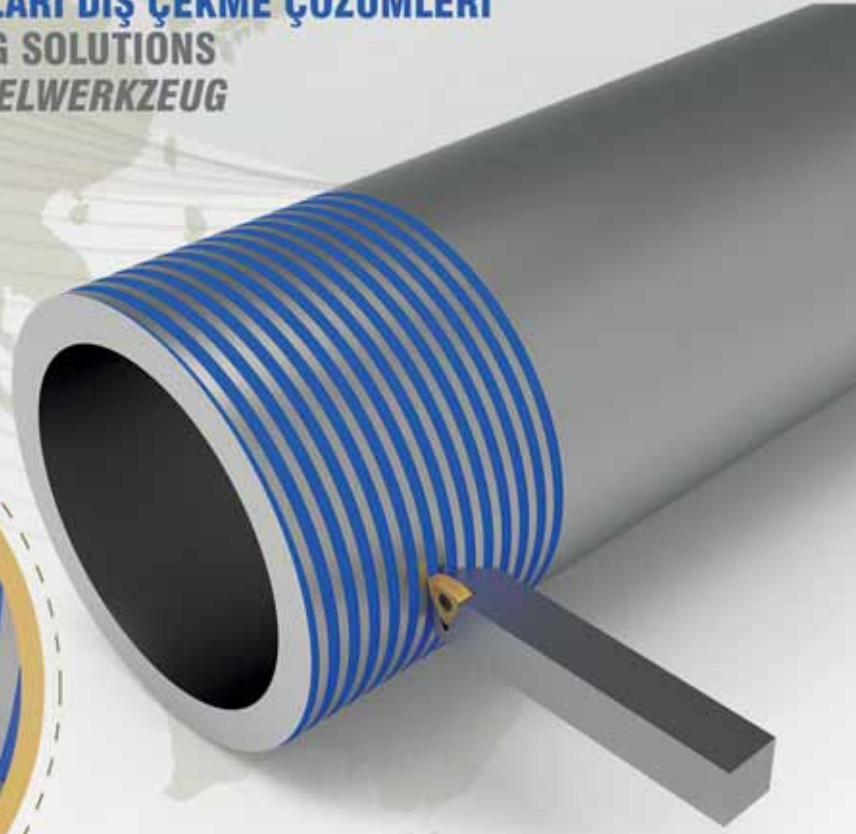

**ÖZEL FORM DIŐ ÇEKME ÇÖZÜMLERİ**  
**SPECIAL FORM THREADING SOLUTIONS**  
**LÖSUNGEN ZUM GEWİNDEDREHEN**  
**VON SONDERFORMEN**



**STICK BLADE – KONVOID BLADE KONİK DİŞLİ AÇMA ÇÖZÜMLERİ**  
**STICK BLADE – KONVOID BLADE BEVEL GEAR SOLUTIONS**  
**LÖSUNGEN FÜR STICK BLADE- KONVOID BLADE MIT KEGELRADGETRIEBE**

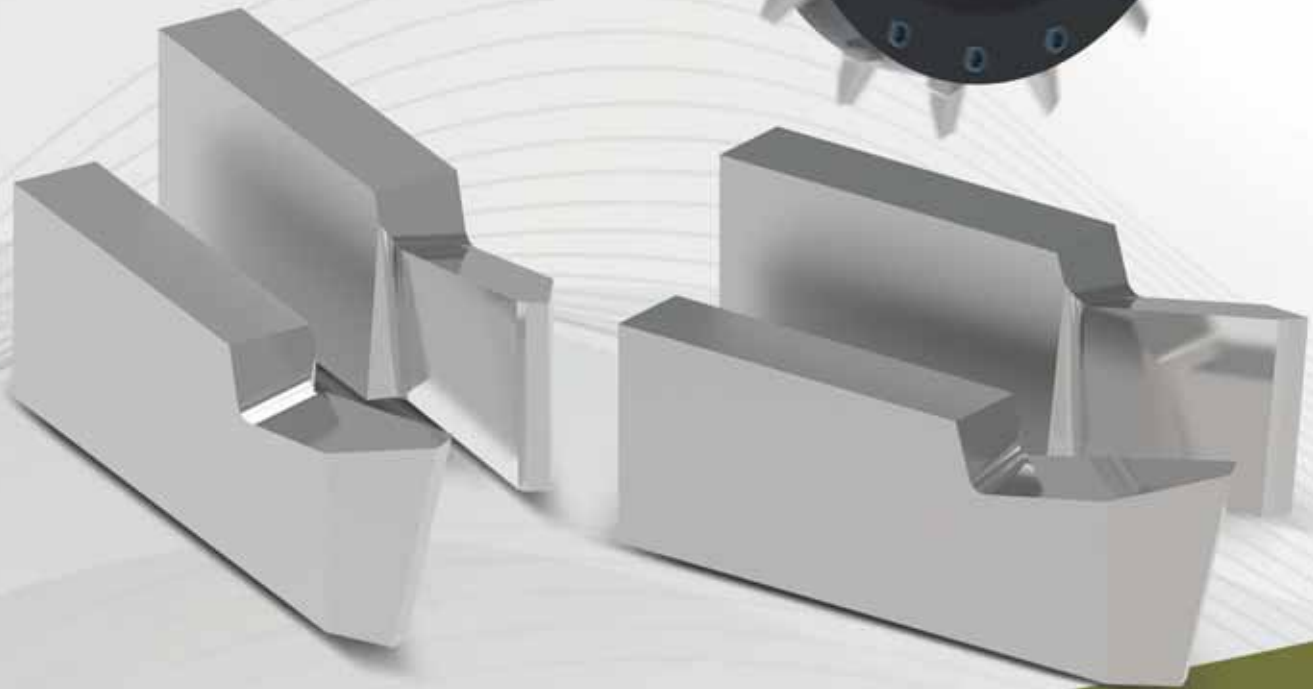
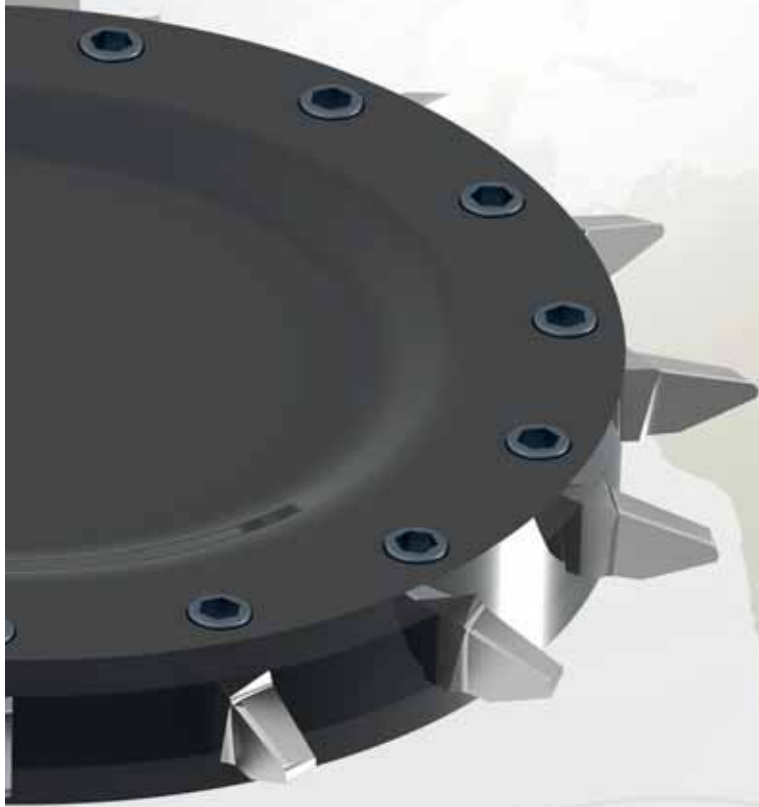





**ZİNCİR DİŞLİ BROŞ ÇÖZÜMLERİ**  
**CHAIN SPROCKETS BROACHING SOLUTIONS**  
**LÖSUNGEN MIT KETTENFORM**  
**ZUR NUTUNGSBEARBEITUNGEN**



**SONSUZ DİŞLİ TORNALAMA ÇÖZÜMLERİ**  
**WORM GEAR TURNING SOLUTIONS**  
**DREHLÖSUNGEN MIT ZAHNSTANGENGETRIEBE**

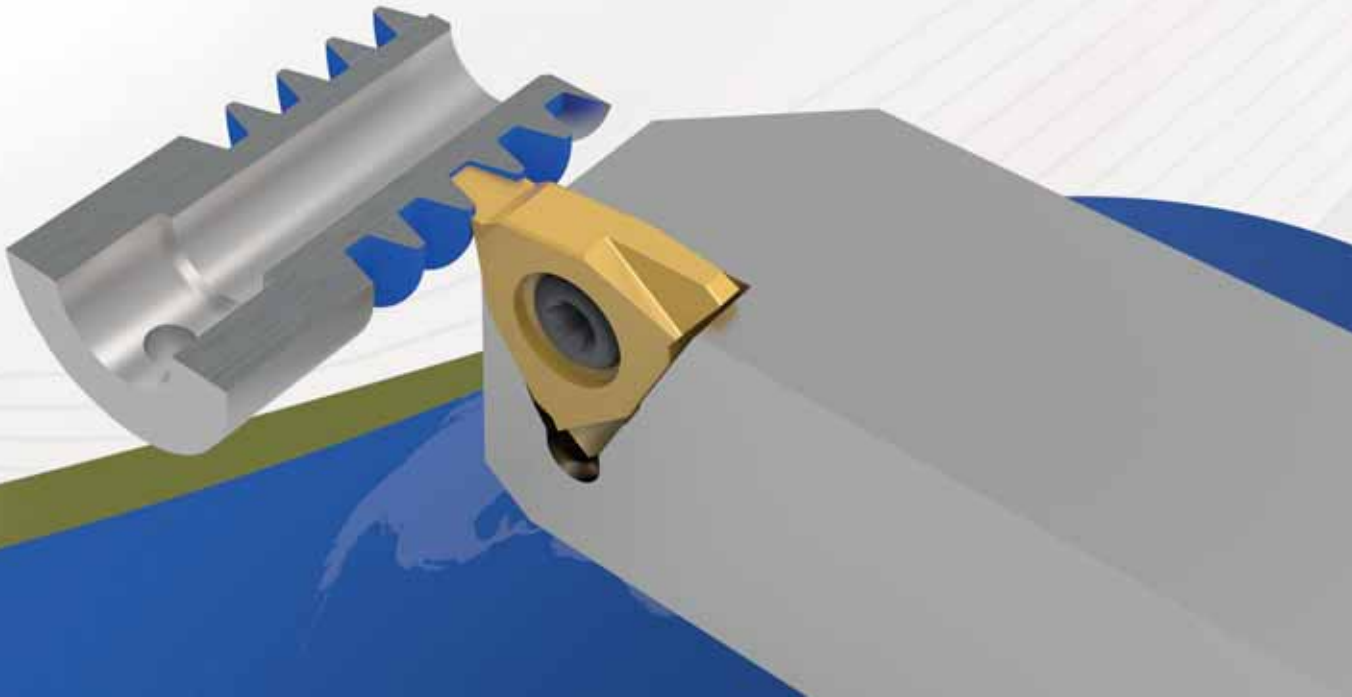

# SUPAP

**SUPAP YUVASI İŞLEME UÇLARI ve TAKIMLARI**  
*VALVE SEAT INSERTS and TOOLHOLDERS*  
*WENDESCHNEIDPLATTEN UND WERKZEUGE FÜR*  
*VENTILSITZBEARBEITUNG*



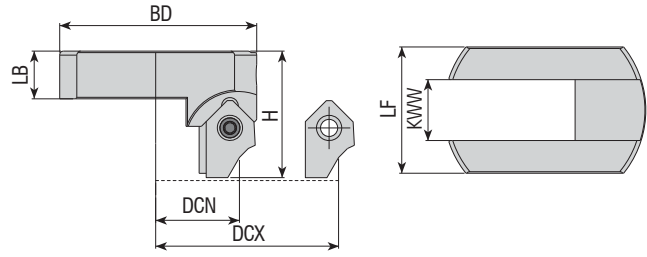

Takım Kodu Ordering Code Bestell-Bezeichnung	Stok Stock Lager	Takım Ölçüleri (mm) Dimension (mm) Abmessung (mm)						Kesici Uç Insert Wendeschneidplatte	Yedek Parçaları / Spare Parts / Ersatzteile				
		DCN DCX	BD	LB	H	KWW	LF		Sıkma Vidası Screw Schraube	Tork Anahtar Torx Key Torx-Schlüssel	Ayar Vidası Adjustable Einstellschraube	Anahtar Allen Key Innensechskantschlüssel	
VST-B11-2842	●	28-42	29	9.5	28.5	12	25.0						
VST-B11-4058	●	40-58	39	9.5	25.0	12	25.0	B11...	3008-M3x8	80-T08	2725-M5x10	AAL-01-02	

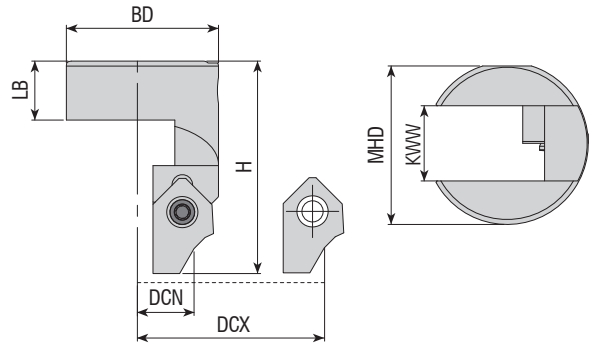

Takım Kodu Ordering Code Bestell-Bezeichnung	Stok Stock Lager	Takım Ölçüleri (mm) Dimension (mm) Abmessung (mm)							Kesici Uç Insert Wendeschneidplatte	Yedek Parçaları / Spare Parts / Ersatzteile				
		DCN DCX	BD	LB	H	KWW	MHD	Sıkma Vidası Screw Schraube		Tork Anahtar Torx Key Torx-Schlüssel	Ayar Vidası Adjustable Einstellschraube	Anahtar Allen Key Innensechskantschlüssel		
VST-B11-1830-A	●	18-30	24	9.5	34.0	12	25.3							

R: Sağ / Right / Rechts L: Sol / Left / Links

● Stokta / In Stock / Auf Lager ○ Stokta Yok / Non Stock Item / Kein Lagerartikel, Lieferzeit auf Anfrage

Sipariş Örneği/Ordering Example/Bestellbeispiel

1 ad./pcs./stück VST-B11-2842

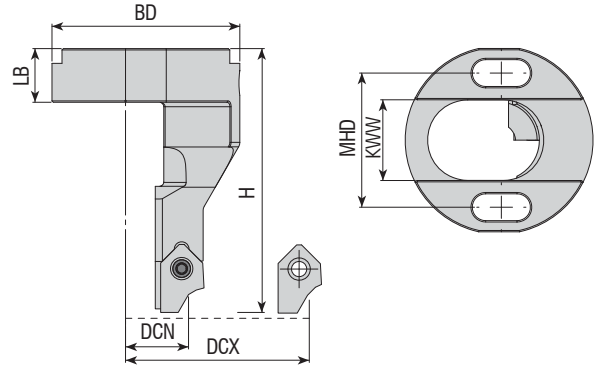

Takım Kodu Ordering Code Bestell-Bezeichnung	Stok Stock Lager	Takım Ölçüleri (mm) Dimension (mm) Abmessung (mm)						Kesici Uç Insert Wendeschneidplatte	Yedek Parçaları / Spare Parts / Ersatzteile				
		DCN DCX	BD	LB	H	KWW	MHD		Sıkma Vidası Screw Schraube	Tork Anahtar Torx Key Torx-Schlüssel	Ayar Vidası Adjustable Einstellschraube	Anahtar Allen Key Innensechskantschlüssel	
VST-B11-2032-A	●	20-32	42	12	59	18	30	B11...	3008-M3x8	80-T08	2702-M4x10	AAL-01-02	
VST-B11-2434-A	●	24-34	26	14	40	11	18.1						
VST-B11-2956-A	●	26-56	49	11.7	43.7	18	40						

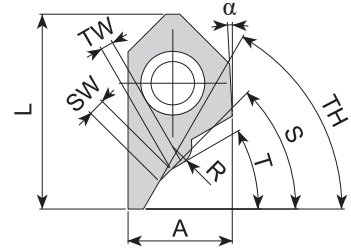

Uç Kodu Insert Code Wendeschneidplatten-Bezeichnung	Stok Stock Lager	Uç Ölçüleri (mm) Insert Dimension (mm) Abmessung (mm)								
		S°	SW	T°	TW	TH°	A	L	α	R
B11013	●	45°	1.3	30°	1	60°	8.15	15.10	3°	1.50

R: Sağ / Right / Rechts L: Sol / Left / Links  
 ● Stokta / In Stock / Auf Lager ○ Stokta Yok / Non Stock Item / Kein Lagerartikel, Lieferzeit auf Anfrage

Sipariş Örneği/Ordering Example/Bestellbeispiel  
 1 ad./pcs./stück VST-B11-2032

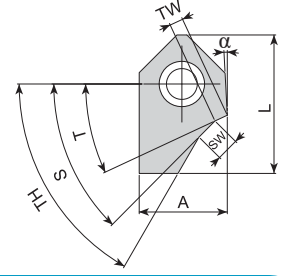

Uç Kodu  
Insert Code  
Wendepplatten-Bezeichnung

Stok  
Stock  
Lager

Uç Ölçüleri (mm)  
Insert Dimension (mm)  
Abmessung (mm)

		S°	SW	T°	TW	TH°	A	L	α
B11003	●	45°	1.3	25°	1.1	52°	9.7	15.25	3°
B11004	●	45°	1.6	25°	1.3	52°	9.7	15.25	3°
B11005	●	45°	2	25°	1.3	52°	9.7	15.25	3°
B11006	●	45°	2.5	25°	1.5	52°	9.7	15.25	3°
B11007	●	45°	1.5	30°	1.5	60°	9.7	15.25	3°
B11008	●	45°	1.3	25°	1.1	60°	9.7	15.25	3°
B11009	●	45°	1.6	25°	1.3	60°	9.7	15.25	3°
B11010	●	45°	2	25°	1.3	60°	9.7	15.25	3°
B11011	●	30°	2	15°	1.8	60°	9.7	15.25	3°
B11012	●	36°	2	15°	1.6	60°	9.7	15.25	3°
B11014	●	45°	2.5	25°	1.5	60°	9.7	15.25	3°
B11016	●	30°	1.5	15°	1.3	60°	9.7	15.25	3°
B11017	●	30°	2.5	15°	1.8	60°	9.7	15.25	3°
B11018	●	36°	2.5	15°	1.6	60°	9.7	15.25	3°
B11019	●	20°	2.5	10°	2	75°	9.7	15.25	3°
B11020	●	45°	1.3	25°	1.1	52°	7.7	15.25	3°
B11021	●	30°	3	15°	1.8	60°	9.7	15.25	3°
B11022	●	45°	3	30°	1.8	60°	9.7	15.25	3°
B11029	●	40°	2.5	25°	1.5	60°	9.7	15.25	3°
B11030	●	20°	2	10°	1.3	60°	9.7	15.25	3°
B11031	●	45°	1.8	30°	1.3	60°	9.7	15.25	3°
B11032	●	45°	1.5	30°	1	52°	9.7	15.25	3°
B11033	●	45°	2	30°	1.1	52°	9.7	15.25	3°
B11034	●	45°	2.5	30°	1.3	52°	9.7	15.25	3°
B11035	●	30°	1.5	15°	1	45°	9.7	15.25	3°
B11036	●	30°	2	15°	1.1	45°	9.7	15.25	3°
B11037	●	30°	2.5	15°	1.3	45°	9.7	15.25	3°
new B11038	●	25°	2	15°	2	45°	9.7	15.25	3°
new B11039	●	30°	2	15°	1.4	60°	9.7	15.25	3°
new B11040	●	40°	2	15°	2	60°	9.7	15.25	3°
new B11042	●	45°	1	30°	1.2	60°	9.7	15.25	3°
new B11043	●	45°	1	35°	1,6	52°	9.7	15.25	3°
new B11044	●	45°	1,3	30°	1	60°	9.7	15.25	3°
new B11045	●	45°	1,5	30°	1	60°	9.7	15.25	3°
new B11046	●	45°	1,8	30°	1	60°	9.7	15.25	3°
new B11047	●	45°	1,8	30°	1,6	60°	9.7	15.25	3°
new B11048	●	45°	1	25°	1,4	60°	9.7	15.25	3°
new B11049	●	45°	1,50	25°	1,4	60°	9.7	15.25	3°
new B11050	●	45°	2	25°	1,4	60°	9.7	15.25	3°
new B11051	●	45°	3	25°	1,4	60°	9.7	15.25	3°
new B11052	●	30°	1,5	15°	1,4	60°	9.7	15.25	3°
new B11053	●	30°	2,5	15°	1,8	60°	9.7	15.25	3°
new B11054	●	45°	1	15°	1	60°	9.7	15.25	3°
new B11055	●	45°	1,5	30°	1,8	60°	9.7	15.25	3°
new B11056	●	45°	2	30°	1,2	60°	9.7	15.25	3°
new B11058	●	35°	2	15°	1,6	60°	9.7	15.25	3°
new B11061	●	45°	1	25°	1,0	60°	9.7	15.25	3°
new B11062	●	30°	1,3	15°	1,0	52°	9.7	15.25	3°
new B11063	●	38°	2,5	15°	1,60	60°	9.7	15.25	3°
new B11064	●	30°	2	15°	1,40	60°	9.7	15.25	3°
new B11065	●	45°	1	25°	0,8	52°	9.7	15.25	3°
new B11066	●	20°	3	10°	2,0	75°	9.7	15.25	3°
new B11069	●	30°	3	15	1,8	45	9.7	15.25	3°

Sipariş Örneği/Ordering Example/Bestellbeispiel  
1 ad./pcs./stück B11003

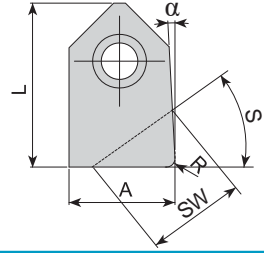

Uç Kodu Insert Code Wendeplatten-Bezeichnung	Stok Stock Lager	Uç Ölçüleri (mm) Insert Dimension (mm) Abmessung (mm)					
		S°	SW	A	L	α	R
B11015	●	0°	9.85	9.85	15.10	3°	0.80
B11023	●	0°	7.7	7.7	15.10	3°	0.80
B11024	●	20°	8.2	9.75	15.10	3°	-
B11025	●	25°	10	9.65	15.10	3°	-
B11026	●	30°	9	9.65	15.10	3°	-
B11027	●	35°	10	9.60	15.10	3°	-
B11028	●	45°	8.9	9.55	15.10	3°	-
B11057	●	0	9.6	9.7	14.8	1°	0.2
B11067	●	0	9.9	9.7	15.1	3°	0.2

R: Sağ / Right / Rechts L: Sol / Left / Links

● Stokta / In Stock / Auf Lager ○ Stokta Yok / Non Stock Item / Kein Lagerartikel, Lieferzeit auf Anfrage

Sipariş Örneği/Ordering Example/Bestellbeispiel

1 ad./pcs./stück B11015

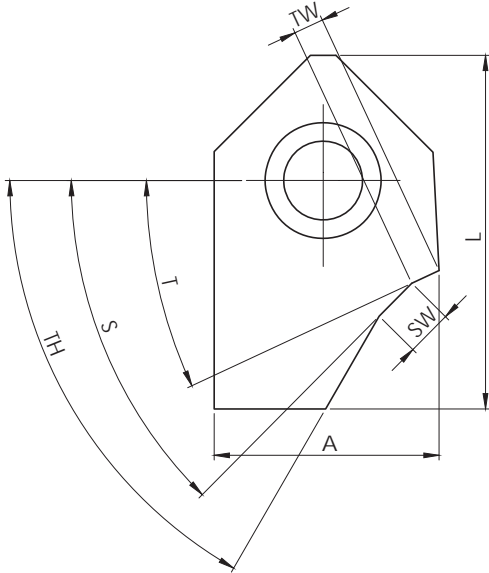

### SUBAP UCU BİLGİ ALMA FORMU

INFORMATION REQUEST FORM FOR VALVE SEAT INSERTS  
 INFORMATIONSFORMULAR FÜR VENTILSITZE

TW :	
L :	
SW :	
A :	
T° :	
S° :	
TH° :	
İLETİŞİM İÇİN: CONTACT: KONTAKT:	

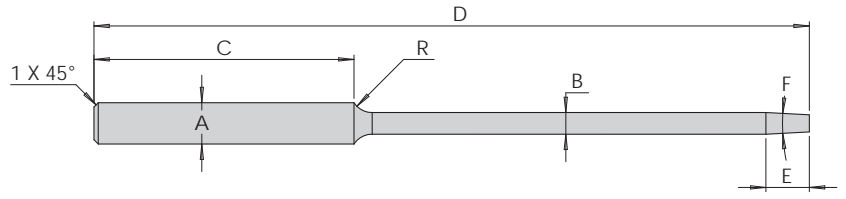

Uç Kodu  
Insert Code  
Wendepplatten-Bezeichnung

Stok  
Stock  
Lager

Uç Ölçüleri (mm)  
Insert Dimension (mm)  
Abmessung (mm)

Uç Kodu Insert Code Wendepplatten-Bezeichnung	Stok Stock Lager	Ø B (h7)	C	R	D	Ø A (h6)	E	F
ACPM-0497-165	●	4.97	60	5	165	9.525	10	6°
ACPM-0498-165	●	4.98	60	5	165	9.525	10	6°
ACPM-0499-165	●	4.99	60	5	165	9.525	10	6°
ACPM-0500-165	●	5.00	60	5	165	9.525	10	6°
ACPM-0549-165	●	5.49	60	5	165	9.525	10	6°
ACPM-0550-165	●	5.50	60	5	165	9.525	10	6°
ACPM-0597-165	●	5.97	60	5	165	9.525	10	6°
ACPM-0598-165	●	5.98	60	5	165	9.525	10	6°
ACPM-0599-165	●	5.99	60	5	165	9.525	10	6°
ACPM-0600-165	●	6.00	60	5	165	9.525	10	6°
ACPM-0605-165	●	6.05	60	5	165	9.525	10	6°
ACPM-0606-165	●	6.06	60	5	165	9.525	10	6°
ACPM-0659-165	●	6.59	60	5	165	9.525	10	6°
ACPM-0660-165	●	6.60	60	5	165	9.525	10	6°
ACPM-0697-165	●	6.97	60	5	165	9.525	10	6°
ACPM-0698-165	●	6.98	60	5	165	9.525	10	6°
ACPM-0699-165	●	6.99	60	5	165	9.525	10	6°
ACPM-0700-165	●	7.00	60	5	165	9.525	10	6°
ACPM-0797-165	●	7.97	60	5	165	9.525	10	6°
ACPM-0798-165	●	7.98	60	5	165	9.525	10	6°
ACPM-0799-165	●	7.99	60	5	165	9.525	10	6°
ACPM-0800-165	●	8.00	60	5	165	9.525	10	6°
ACPM-0801-165	●	8.01	60	5	165	9.525	10	6°
ACPM-0802-165	●	8.02	60	5	165	9.525	10	6°
ACPM-0803-165	●	8.03	60	5	165	9.525	10	6°
ACPM-0824-165	●	8.24	60	5	165	9.525	10	6°
ACPM-0825-165	●	8.25	60	5	165	9.525	10	6°
ACPM-0849-165	●	8.49	60	5	165	9.525	10	6°
ACPM-0850-165	●	8.50	60	5	165	9.525	10	6°
ACPM-0897-165	●	8.97	60	5	165	9.525	10	6°
ACPM-0898-165	●	8.98	60	5	165	9.525	10	6°
ACPM-0899-165	●	8.99	60	5	165	9.525	10	6°
ACPM-0900-165	●	9.00	60	5	165	9.525	10	6°

R: Sağ / Right / Rechts L: Sol / Left / Links

● Stokta / In Stock / Auf Lager ○ Stokta Yok / Non Stock Item / Kein Lagerartikel, Lieferzeit auf Anfrage

Sipariş Örneği/Ordering Example/Bestellbeispiel

1 ad./pcs./stück ACPM-0497-165

# U-DRILL

TAKMA UÇLU MATKAPLAR  
U-DRILL SYSTEM  
VOLLBOHRER







**AKKO** **A** **TUM** **16** x **D3**

**S** **P** **G** **T** **06** **02** **04**

**2** Kesici Stili / Cutter Style / Werkzeugtyp

TUM: Takma Uçlu Matkap U-Drill Vollbohrer

**3** Takım Çapı / Tool Diameter / Werkzeugdurchmesser

**4** Delme Derinliği / Drilling Depth / Bohrtiefe

**5** Uç Şekli / Insert Form / Plattenform

**W** **S**

**6** Serbest Uç Açısı / Clearance angle of Insert / Freiwinkel der Wendeschneidplatte

**C** **P**

**8** Uç Tipi / Insert Type / Plattentyp

A  $\beta = 70-90^\circ$  J  $\beta = 70-90^\circ$  T  $\beta = 40-60^\circ$   
 B  $\beta = 70-90^\circ$  M  $\beta = 40-60^\circ$  U  $\beta = 40-60^\circ$   
 C  $\beta = 70-90^\circ$  N  $\beta = 40-60^\circ$  W  $\beta = 40-60^\circ$   
 F  $\beta = 40-60^\circ$  Q  $\beta = 40-60^\circ$   
 G  $\beta = 40-60^\circ$  R  $\beta = 40-60^\circ$  X Özel / Special / Sonder  
 H  $\beta = 70-90^\circ$

**10** Kalınlık / Thickness / Dicke

01 s = 1,59  
 T1 s = 1,98  
 02 s = 2,38  
 T2 s = 2,78  
 03 s = 3,18  
 T3 s = 3,97  
 04 s = 4,76  
 05 s = 5,56  
 06 s = 6,35  
 07 s = 7,94  
 09 s = 9,52

**7** Toleranslar / Tolerance Classes / Toleranzen

	IC	M	S
A	± 0.025	± 0.005	± 0.025
C	± 0.025	± 0.013	± 0.025
E	± 0.025	± 0.025	± 0.025
F	± 0.013	± 0.005	± 0.025
G	± 0.025	± 0.025	± 0.130
H	± 0.013	± 0.013	± 0.025
J	± 0.05-0.15	± 0.005	± 0.025
K	± 0.05-0.15	± 0.013	± 0.025
L	± 0.05-0.15	± 0.025	± 0.025
M	± 0.05-0.15	± 0.08-0.20	± 0.130
N	± 0.05-0.15	± 0.08-0.20	± 0.025
U	± 0.08-0.25	± 0.13-0.38	± 0.130

IC : Daire Ölçüsü / Inscribed Circle / Kreisgröße  
 M : Şekle Göre / Refer to Figure / Siehe Abbildung  
 S : Kalınlık / Thickness / Dicke

**9** Kesme Kenar Uzunluğu / Cutting Edge Length / Schneidkantenlänge

**11** Köşe Konfigürasyonu / Corner Radius / Eckenradius

01 r = 0.1  
 02 r = 0.2  
 04 r = 0.4  
 08 r = 0.8  
 12 r = 1.2  
 16 r = 1.6  
 24 r = 2.4

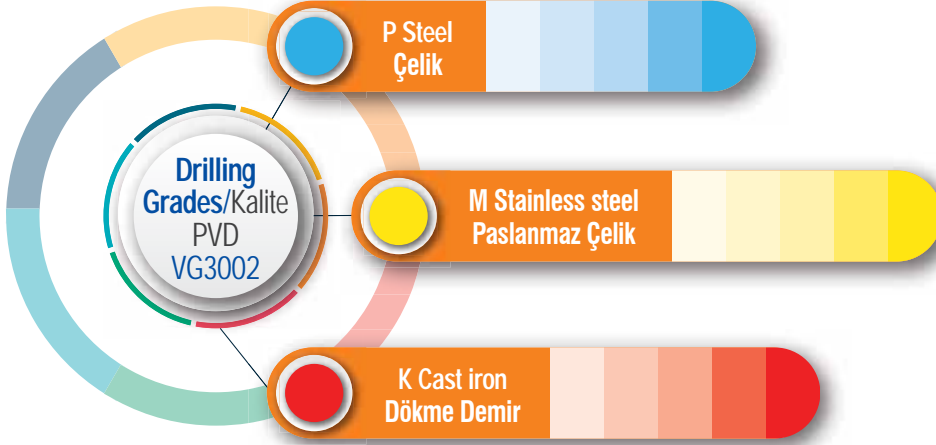

4 Corner / 4 Köşeli  
SPMX Series / Serileri  
00, 01, 02, 03, 04, 05



ISO 3 Corner / 3 Köşeli  
WCMX Series / Serileri  
00, 01, 02, 03, 04, 05

## Grade Information / Kalite Bilgileri

PVD - TiAIN

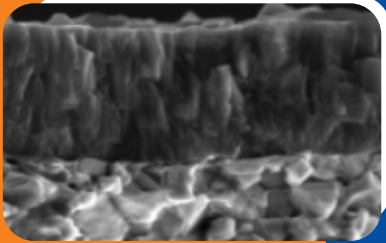

### Universal grade for General Drilling Application

- Ultra Dense PVD Coating with optimal thermal resistance & strength
- Sub-Micron substrate designed for demanding application

### Genel Delme Uygulaması için evrensel kalite

- Optimum termal direnç ve güce sahip Ultra Yoğun PVD Kaplama
- Zorlu uygulama için tasarlanmış alt Mikron tabaka

METRIC		DRILLING	
ISO	SUB GROUP / ALT GRUP	MIN	MAX
		Vc (m/min) VG3002	
P	Non Alloy Steel / Alaşımız Çelik	180	280
	Low Alloy Steel / Düşük Alaşım Çelik	150	250
	High Alloy Steel / Yüksek Alaşım Çelik	70	140
M	Ferritic & Martensitic / Ferritik Ve Martenzitik	120	200
	Austenitic Stainless Steel / Östenitik Paslanmaz Çelik	130	250
	Grey Cast Iron / Gri Dökme Demir	120	250
	Nodular Cast Iron / Sferö Döküm Demir	130	220
N	Aluminum / Alüminyum	-	-
S	Titanium & Super Alloy / Titanyum Ve Süper Alaşım	25	45
H	Hardened Material / Sertleştirilmiş Malzeme	-	-



P20 – P35

M20 – M40

K20 – K40

S15 – S25



## Drilling Chipbreakers / Talaş Kırıcı Formlar



-ST



- Sharp Geometry / Keskin Geometri
- Sticky Material, Stainless Steel  
Yapışkan Malzeme, Paslanmaz Çelik

General Inserts  
Genel Uçlar



- First Choice for General Application  
Genel Uygulama İçin İlk Tercih

INCH		DRILLING Vc (m/min) VG3002	
ISO	SUB GROUP / ALT GRUP	MIN	MAX
P	Non Alloy Steel / Alaşimsız Çelik	591	919
	Low Alloy Steel / Düşük Alaşımli Çelik	492	820
	High Alloy Steel / Yüksek Alaşımli Çelik	230	459
M	Ferritic & Martensitic / Ferritik Ve Martenzitik	394	656
	Austenitic Stainless Steel / Östenitik Paslanmaz Çelik	427	820
K	Grey Cast Iron / Gri Dökme Demir	394	820
	Nodular Cast Iron / Sterö Döküm Demir	427	711
N	Aluminum / Alüminyum	-	-
S	Titanium & Super Alloy / Titanyum Ve Süper Alaşım	82	148
H	Hardened Material / Sertleştirilmiş Malzeme	-	-

## Drilling Insert / Delik Delme Ucu (SPMX)

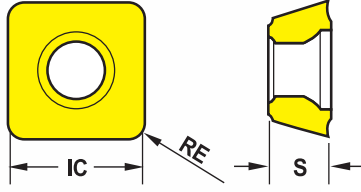

	IC	S
Metric	5	2.38
Inch	0.197	0.094
Metric	6	2.41
Inch	0.236	0.094
Metric	7.94	3.97
Inch	0.313	0.156
Metric	9.8	4.3
Inch	0.386	0.169
Metric	11.5	4.8
Inch	0.453	0.189
Metric	14.3	5.2
Inch	0.563	0.205

ISO 4 Corner  
SPMX Series  
00, 01, 02, 03, 04, 05



EDP	DESCRIPTION	AÇIKLAMA	FEED RATE	İLERLEME
T.01.07.02.00	SPMX050204-VG3002		mm/rev.	0.07~0.14
			Inch/rev.	.003~.006
T.01.07.02.01	SPMX060204-VG3002		mm/rev.	0.08~0.14
			Inch/rev.	.003~.006
T.01.07.02.02	SPMX07T308-VG3002		mm/rev.	0.08~0.16
			Inch/rev.	.003~.006
T.01.07.02.03	SPMX090408-VG3002		mm/rev.	0.08~0.16
			Inch/rev.	.003~.006
T.01.07.02.04	SPMX110408-VG3002		mm/rev.	0.10~0.18
			Inch/rev.	.004~.007
T.01.07.02.05	SPMX140512-VG3002		mm/rev.	0.10~0.20
			Inch/rev.	.004~.008

Cutting Speed / Kesme Hızı			Vc (ft/min)	
ISO	VDI	Sub Group / Alt Grup	VG3002	
			Min	Max
P	1~5	Non-Alloyed Steel / Alaşimsız Çelik	460	1250
	6~9	Low-Alloyed Steel / Düşük Alaşımli Çelik	390	980
	10~11	High-Alloyed Steel / Yüksek Alaşımli Çelik	230	490
M	12~13	Ferritic & Martensitic / Ferritik Ve Martenzitik	390	660
	14	Austenitic Stainless Steel / Östenitik Paslanmaz Çelik	430	820
K	15~16	Grey Cast Iron / Gri Dökme Demir	390	820
	17~18	Nodular Cast Iron / Sferö Döküm Demir	430	720

## Drilling Insert / Delik Delme Ucu (WCMX)

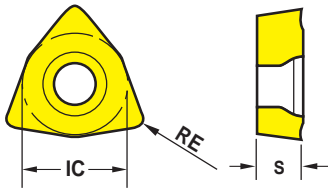

	IC	S
Metric	5.56	2.38
Inch	0.219	0.094
Metric	6.35	2.38
Inch	0.236	0.094
Metric	7.94	3.18
Inch	0.313	0.125
Metric	9.53	3.97
Inch	0.375	0.156
Metric	12.7	4.76
Inch	0.500	0.187



ISO 3 Corner  
WCMX Series  
01, 02, 03, 04, 05



EDP	DESCRIPTION	AÇIKLAMA	FEED RATE	İLERLEME
T.01.07.01.01	WCMX030208-VG3002		mm/rev.	0.05~0.12
			Inch/rev.	.002~.005
T.01.07.01.02	WCMX040208-VG3002		mm/rev.	0.05~0.12
			Inch/rev.	.002~.005
T.01.07.01.03	WCMX050308-VG3002		mm/rev.	0.06~0.14
			Inch/rev.	.002~.006
T.01.07.01.04	WCMX06T308-VG3002		mm/rev.	0.08~0.14
			Inch/rev.	.003~.006
T.01.07.01.05	WCMX080412-VG3002		mm/rev.	0.08~0.14
			Inch/rev.	.003~.006

Cutting Speed / Kesme Hızı			Vc (ft/min)	
ISO	VDI	Sub Group / Alt Grup	VG3002	
			Min	Max
P	1-5	Non-Alloyed Steel / Alaşimsız Çelik	460	1250
	6-9	Low-Alloyed Steel / Düşük Alaşımli Çelik	390	980
	10-11	High-Alloyed Steel / Yüksek Alaşımli Çelik	230	490
M	12-13	Ferritic & Martensitic / Ferritik Ve Martenzitik	390	660
	14	Austenitic Stainless Steel / Östenitik Paslanmaz Çelik	430	820
K	15-16	Grey Cast Iron / Gri Dökme Demir	390	820
	17-18	Nodular Cast Iron / Sferö Döküm Demir	430	720



Delme Derinliği  
Drilling Depth  
Bohrtiefe

= 2x Çap  
= 2x Diameter  
= 2x Durchmesser

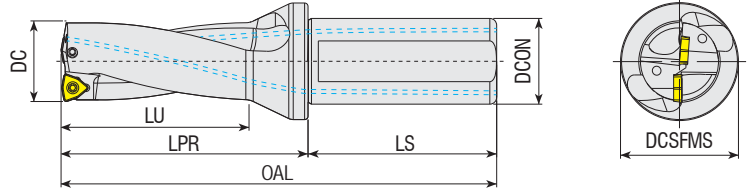

**Takım Kodu**  
**Ordering Code**  
**Bestell-Bezeichnung**

Stok  
Stock  
Lager

Takım Ölçüleri (mm)  
Dimension (mm)  
Abmessung (mm)

Maks. Ofset (radyal)  
Max. Ofset (radial)  
Max. Versatz (radial)

Kesici Uç  
Insert  
Wendeschneidplatte

Yedek Parçaları / Spare Parts / Ersatzteile

Sıkma Vidası  
Screw  
Schraube

Tork Anahtar  
Torx Key  
Torx-Schlüssel

DC

DCON

DCSFMS

OAL

LU

LPR

LS

X<sub>max</sub>

DC<sub>max</sub> [mm]

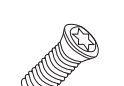

Takım Kodu Ordering Code Bestell-Bezeichnung	Stok Stock Lager	DC	DCON	DCSFMS	OAL	LU	LPR	LS	Maks. Ofset (radyal) Max. Ofset (radial) Max. Versatz (radial)	Kesici Uç Insert Wendeschneidplatte	Sıkma Vidası Screw Schraube	Tork Anahtar Torx Key Torx-Schlüssel	
ATUM 16XD2 WCM. 030208	●	16	25	34	110	32	54	56	1.5	19	WCM. 030208	3008-M2.5x6	82-T08
ATUM 16.5XD2 WCM. 030208	●	16.5	25	34	110	32	54	56	1.5	19.5			
ATUM 17XD2 WCM. 030208	●	17	25	34	112	34	56	56	1.5	20			
ATUM 17.5XD2 WCM. 030208	●	17.5	25	34	112	34	56	56	1.5	20.5			
ATUM 18XD2 WCM. 030208	●	18	25	34	114	36	58	56	1.4	20.8			
ATUM 18.5XD2 WCM. 030208	●	18.5	25	34	114	36	58	56	1.3	21.1			
ATUM 19XD2 WCM. 030208	●	19	25	34	116	38	60	56	1.2	21.4			
ATUM 19.5XD2 WCM. 030208	●	19.5	25	34	116	38	60	56	1.2	21.9			
ATUM 20XD2 WCM. 040208	●	20	25	34	118	40	62	56	1.5	23	WCM. 040208	3008-M2.5x6	82-T08
ATUM 20.5XD2 WCM. 040208	●	20.5	25	34	118	40	62	56	1.5	23.5			
ATUM 21XD2 WCM. 040208	●	21	25	34	120	42	64	56	1	23			
ATUM 21.5XD2 WCM. 040208	●	21.5	25	34	120	42	64	56	1	23.5			
ATUM 22XD2 WCM. 040208	●	22	25	34	122	44	66	56	1	24			
ATUM 22.5XD2 WCM. 040208	●	22.5	25	34	122	44	66	56	1	24.5			
ATUM 23XD2 WCM. 040208	●	23	25	34	124	46	68	56	1	25			
ATUM 23.5XD2 WCM. 040208	●	23.5	25	34	124	46	68	56	1	25.5			
ATUM 24XD2 WCM. 050308	●	24	25	34	126	48	70	56	1.4	26.8	WCM. 050308	3008-M3x8	82-T08
ATUM 24.5XD2 WCM. 050308	●	24.5	25	34	126	48	70	56	1.4	27.3			
ATUM 25XD2 WCM. 050308	●	25	25	34	128	50	72	56	1.45	27.9			
ATUM 25.5XD2 WCM. 050308	●	25.5	25	34	128	50	72	56	1.45	28.4			
ATUM 26XD2 WCM. 050308	●	26	25	34	130	52	74	56	1.45	28.9			
ATUM 26.5XD2 WCM. 050308	●	26.5	25	34	130	52	74	56	1.45	29.4			
ATUM 27XD2 WCM. 050308	●	27	25	34	132	54	76	56	1.45	29.9			
ATUM 27.5XD2 WCM. 050308	●	27.5	25	34	132	54	76	56	1.45	30.4			
ATUM 28XD2 WCM. 050308	●	28	25	34	134	56	78	56	1.6	31.2			
ATUM 28.5XD2 WCM. 050308	●	28.5	25	34	134	56	78	56	1.6	31.7			
ATUM 29XD2 WCM. 050308	●	29	25	34	136	58	80	56	1.65	32.3			
ATUM 29.5XD2 WCM. 050308	●	29.5	25	34	136	58	80	56	1.65	32.8			

R: Sağ / Right / Rechts | L: Sol / Left / Links  
● Stokta / In Stock / Auf Lager ○ Stokta Yok / Non Stock Item / Kein Lagerartikel, Lieferzeit auf Anfrage  
ISO Ucuna Uygunudur. / Compatible with ISO Insert. / Kompatibel mit ISO Wendeplatten.

Sipariş Örneği/Ordering Example/Bestellbeispiel  
1 ad./pcs./stück ATUM 16XD2 WCM. 030208

Takma Uçlu Matkap Kullanım Kılavuzu : S 375 / User's Guide For U-Drills : P 375  
Bedienungsanleitung für Vollbohrer : S 375



Delme Derinliği  
Drilling Depth  
Bohrtiefe = 2x Çap  
= 2x Diameter  
= 2x Durchmesser

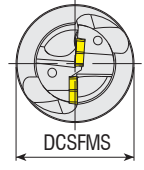
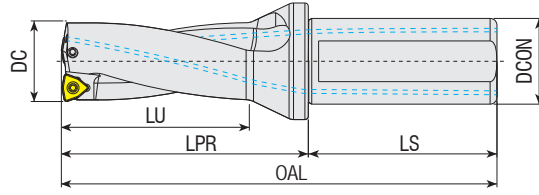

Takım Kodu Ordering Code Bestell-Bezeichnung	Stok Stock Lager	Takım Ölçüleri (mm) Dimension (mm) Abmessung (mm)							Maks. Ofset (radyal) Max. Offset (radial) Max. Versatz (radial)		Kesici Uç Insert Wendeschneidplatte	Yedek Parçaları / Spare Parts / Ersatzteile	
		DC	DCON	DCSFMS	OAL	LU	LPR	LS	$X_{max}$	$DC_{max}$		Sıkma Vidası Screw Schraube	Tork Anahtar Torx Key Torx-Schlüssel
ATUM 30XD2 WCM. 06T308	●	30	32	44	147	60	87	60	2.4	34.8	WCM. 06T308	3010-M3.5x9	82-T10
ATUM 31XD2 WCM. 06T308	●	31	32	44	149	62	89	60	2.3	35.6			
ATUM 32XD2 WCM. 06T308	●	32	32	44	151	64	91	60	2.1	36.2			
ATUM 33XD2 WCM. 06T308	●	33	32	44	153	66	93	60	1.9	36.8			
ATUM 34XD2 WCM. 06T308	●	34	32	44	155	68	95	60	1.9	37.8			
ATUM 35XD2 WCM. 06T308	●	35	32	44	157	70	97	60	1.9	38.8			
ATUM 36XD2 WCM. 06T308	●	36	32	44	159	72	99	60	2	40			
ATUM 37XD2 WCM. 06T308	●	37	32	44	161	74	101	60	1.8	40.6			
ATUM 38XD2 WCM. 06T308	●	38	32	44	163	76	103	60	1.5	41			
ATUM 39XD2 WCM. 06T308	●	39	32	44	165	78	105	60	1.3	41.6			
ATUM 40XD2 WCM. 06T308	●	40	32	44	167	80	107	60	1	42			
ATUM 41XD2 WCM. 06T308	●	41	32	44	169	82	109	60	0.8	42.6			
ATUM 42XD2 WCM. 06T308	●	42	32	44	171	84	111	60	0.5	43			
ATUM 43XD2 WCM. 06T308	●	43	32	44	173	86	113	60	0.3	43.6			
ATUM 44XD2 WCM. 06T308	●	44	32	44	175	88	115	60	0	44			
ATUM 45XD2 WCM. 080412	●	45	40	54	192	90	122	70	3.3	51.6	WCM. 080412	4015-M4x11	80-T15
ATUM 46XD2 WCM. 080412	●	46	40	54	194	92	124	70	3	52			
ATUM 47XD2 WCM. 080412	●	47	40	54	196	94	126	70	2.8	52.6			
ATUM 48XD2 WCM. 080412	●	48	40	54	198	96	128	70	2.5	53			
ATUM 49XD2 WCM. 080412	●	49	40	54	200	98	130	70	2.2	53.4			
ATUM 50XD2 WCM. 080412	●	50	40	54	202	100	132	70	2	54			
ATUM 51XD2 WCM. 080412	●	51	40	54	204	102	134	70	1.8	54.6			
ATUM 52XD2 WCM. 080412	●	52	40	54	206	104	136	70	1.5	55			
ATUM 53XD2 WCM. 080412	●	53	40	54	208	106	138	70	1.3	55.6			
ATUM 54XD2 WCM. 080412	●	54	40	54	210	108	140	70	1	56			
ATUM 55XD2 WCM. 080412	●	55	40	54	212	110	142	70	0.8	56.6			
ATUM 56XD2 WCM. 080412	●	56	40	64	214	112	144	70	0.5	57			
ATUM 57XD2 WCM. 080412	●	57	40	64	216	114	146	70	0.3	57.6			
ATUM 58XD2 WCM. 080412	●	58	40	64	218	116	148	70	0	58			
ATUM 59XD2 WCM. 080412	●	59	40	64	220	118	150	70	0	59			
ATUM 60XD2 WCM. 080412	●	60	40	64	222	120	152	70	0	60			

R: Sağ / Right / Rechts L: Sol / Left / Links

● Stokta / In Stock / Auf Lager ○ Stokta Yok / Non Stock Item / Kein Lagerartikel, Lieferzeit auf Anfrage

ISO Ucuna Uygundur. / Compatible with ISO Insert. / Kompatibel mit ISO Wendeplatten.

Sipariş Örneği/Ordering Example/Bestellbeispiel

1 ad./pcs./stück ATUM 30XD2 WCM. 06T308

Takma Uçlu Matkap Kullanım Kılavuzu : S 375 / User's Guide For U-Drills : P 375 / Bedienungsanleitung für Vollbohrer : S 375



Delme Derinliği  
Drilling Depth  
Bohrtiefe

= 3x Çap  
= 3x Diameter  
= 3x Durchmesser

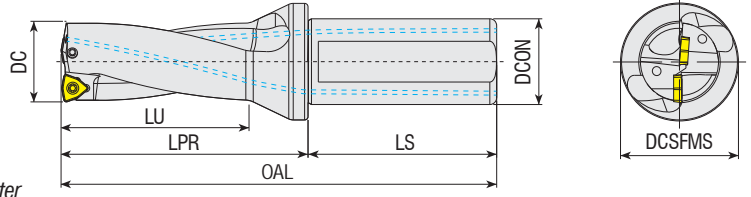

**Takım Kodu**  
Ordering Code  
Bestell-Bezeichnung

Stok  
Stock  
Lager

Takım Ölçüleri (mm)  
Dimension (mm)  
Abmessung (mm)

Maks. Ofset (radyal)  
Max. Offset (radial)  
Max. Versatz (radial)

Kesici Uç  
Insert  
Wendeschneidplatte

Yedek Parçaları / Spare Parts / Ersatzteile

Sıkma Vidası  
Screw  
Schraube

Tork Anahtar  
Torx Key  
Torx-Schlüssel

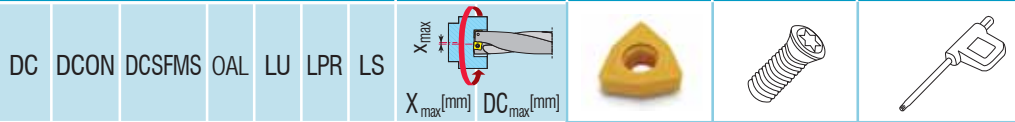

Takım Kodu Ordering Code Bestell-Bezeichnung	Stok Stock Lager	Takım Ölçüleri (mm) Dimension (mm) Abmessung (mm)							Maks. Ofset (radyal) Max. Offset (radial) Max. Versatz (radial)		Kesici Uç Insert Wendeschneidplatte	Sıkma Vidası Screw Schraube	Tork Anahtar Torx Key Torx-Schlüssel
		DC	DCON	DCSEMS	OAL	LU	LPR	LS	$X_{max}$	$DC_{max}$			
ATUM 16XD3 WCM. 030208	●	16	25	34	126	48	70	56	1.5	19	WCM. 030208	3008-M2.5x6	82-T08
ATUM 16.5XD3 WCM. 030208	●	16.5	25	34	126	48	70	56	1.5	19.5			
ATUM 17XD3 WCM. 030208	●	17	25	34	129	51	73	56	1.5	20			
ATUM 17.5XD3 WCM. 030208	●	17.5	25	34	129	51	73	56	1.5	20.5			
ATUM 18XD3 WCM. 030208	●	18	25	34	132	54	76	56	1.4	20.8			
ATUM 18.5XD3 WCM. 030208	●	18.5	25	34	132	54	76	56	1.3	21.1			
ATUM 19XD3 WCM. 030208	●	19	25	34	135	57	79	56	1.2	21.4			
ATUM 19.5XD3 WCM. 030208	●	19.5	25	34	135	57	79	56	1.2	21.9			
ATUM 20XD3 WCM. 040208	●	20	25	34	138	60	82	56	1.5	23	WCM. 040208	3008-M2.5x6	82-T08
ATUM 20.5XD3 WCM. 040208	●	20.5	25	34	138	60	82	56	1.5	23.5			
ATUM 21XD3 WCM. 040208	●	21	25	34	141	63	85	56	1	23			
ATUM 21.5XD3 WCM. 040208	●	21.5	25	34	141	63	85	56	1	23.5			
ATUM 22XD3 WCM. 040208	●	22	25	34	144	66	88	56	1	24			
ATUM 22.5XD3 WCM. 040208	●	22.5	25	34	144	66	88	56	1	24.5			
ATUM 23XD3 WCM. 040208	●	23	25	34	147	69	91	56	1	25			
ATUM 23.5XD3 WCM. 040208	●	23.5	25	34	147	69	91	56	1	25.5			
ATUM 24XD3 WCM. 050308	●	24	25	34	150	72	94	56	1.4	26.8	WCM. 050308	3008-M3x8	82-T10
ATUM 24.5XD3 WCM. 050308	●	24.5	25	34	150	72	94	56	1.4	27.3			
ATUM 25XD3 WCM. 050308	●	25	25	34	153	75	97	56	1.45	27.9			
ATUM 25.5XD3 WCM. 050308	●	25.5	25	34	153	75	97	56	1.45	28.4			
ATUM 26XD3 WCM. 050308	●	26	25	34	156	78	100	56	1.45	28.9			
ATUM 26.5XD3 WCM. 050308	●	26.5	25	34	156	78	100	56	1.45	29.4			
ATUM 27XD3 WCM. 050308	●	27	25	34	159	81	103	56	1.45	29.9			
ATUM 27.5XD3 WCM. 050308	●	27.5	25	34	159	81	103	56	1.45	30.4			
ATUM 28XD3 WCM. 050308	●	28	25	34	162	84	106	56	1.6	31.2			
ATUM 28.5XD3 WCM. 050308	●	28.5	25	34	162	84	106	56	1.6	31.7			
ATUM 29XD3 WCM. 050308	●	29	25	34	165	87	109	56	1.65	32.3			
ATUM 29.5XD3 WCM. 050308	●	29.5	25	34	165	87	109	56	1.65	32.8			
ATUM 30XD3 WCM. 06T308	●	30	32	44	177	90	117	60	2.4	34.8	WCM. 06T308	3010-M3.5x9	82-T10
ATUM 30.5XD3 WCM. 06T308	●	30.5	32	44	177	90	117	60	2.4	35.3			
ATUM 31XD3 WCM. 06T308	●	31	32	44	180	93	120	60	2.3	35.6			
ATUM 31.5XD3 WCM. 06T308	●	31.5	32	44	180	93	120	60	2.3	36.1			
ATUM 32XD3 WCM. 06T308	●	32	32	44	183	96	123	60	2.1	36.2			
ATUM 32.5XD3 WCM. 06T308	●	32.5	32	44	183	96	123	60	2.1	36.7			
ATUM 33XD3 WCM. 06T308	●	33	32	44	186	99	126	60	1.9	36.8			
ATUM 33.5XD3 WCM. 06T308	●	33.5	32	44	186	99	126	60	1.9	37.3			
ATUM 34XD3 WCM. 06T308	●	34	32	44	189	102	129	60	1.9	37.8			
ATUM 34.5XD3 WCM. 06T308	●	34.5	32	44	189	102	129	60	1.9	38.3			

R: Sağ / Right / Rechts/ L: Sol / Left / Links

● Stokta / In Stock / Auf Lager ○ Stokta Yok / Non Stock Item / Kein Lagerartikel, Lieferzeit auf Anfrage  
ISO Ucuna Uygundur. / Compatible with ISO Insert. / Kompatibel mit ISO Wendeplatten.

Sipariş Örneği/Ordering Example/Bestellbeispiel

1 ad./pcs./stück ATUM 16XD3 WCM. 030208

Takma Uçlu Matkap Kullanım Kılavuzu : S 375 / User's Guide For U-Drills : P 375

Bedienungsanleitung für Vollbohrer : S 375





Delme Derinliği  
Drilling Depth  
Bohrtiefe

= 3x Çap  
= 3x Diameter  
= 3x Durchmesser

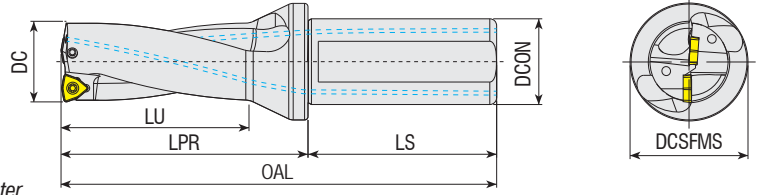

Takım Kodu  
Ordering Code  
Bestell-Bezeichnung

Stok  
Stock  
Lager

Takım Ölçüleri (mm)  
Dimension (mm)  
Abmessung (mm)

Maks. Ofset (radyal)  
Max. Offset (radial)  
Max. Versatz (radial)

Kesici Uç  
Insert  
Wendeschneidplatte

Yedek Parçaları / Spare Parts / Ersatzteile

Sıkma Vidası  
Screw  
Schraube

Tork Anahtar  
Torx Key  
Torx-Schlüssel



Takım Kodu Ordering Code Bestell-Bezeichnung	Stok Stock Lager	Takım Ölçüleri (mm) Dimension (mm) Abmessung (mm)								Maks. Ofset (radyal) Max. Offset (radial) Max. Versatz (radial)		Kesici Uç Insert Wendeschneidplatte	Yedek Parçaları / Spare Parts / Ersatzteile	
		DC	DCON	DCSFMS	OAL	LU	LPR	LS	X <sub>max</sub>	DC <sub>max</sub>	Sıkma Vidası Screw Schraube		Tork Anahtar Torx Key Torx-Schlüssel	
ATUM 35XD3 WCM. 06T308	●	35	32	44	192	105	132	60	1.9	38.8	WCM. 06T308	3010-M3.5x9	82-T10	
ATUM 35.5XD3 WCM. 06T308	●	35.5	32	44	192	105	132	60	1.9	39.3				
ATUM 36XD3 WCM. 06T308	●	36	32	44	195	108	135	60	2	40				
ATUM 36.5XD3 WCM. 06T308	●	36.5	32	44	195	108	135	60	2	40.5				
ATUM 37XD3 WCM. 06T308	●	37	32	44	198	111	138	60	1.8	40.6				
ATUM 37.5XD3 WCM. 06T308	●	37.5	32	44	198	111	138	60	1.8	41.1				
ATUM 38XD3 WCM. 06T308	●	38	32	44	201	114	141	60	1.5	41				
ATUM 38.5XD3 WCM. 06T308	●	38.5	32	44	201	114	141	60	1.5	41.5				
ATUM 39XD3 WCM. 06T308	●	39	32	44	204	117	144	60	1.3	41.6				
ATUM 39.5XD3 WCM. 06T308	●	39.5	32	44	204	117	144	60	1.3	42.1				
ATUM 40XD3 WCM. 06T308	●	40	32	44	207	120	147	60	1	42				
ATUM 40.5XD3 WCM. 06T308	●	40.5	32	44	207	120	147	60	1	42.5				
ATUM 41XD3 WCM. 06T308	●	41	32	44	210	123	150	60	0.8	42.6				
ATUM 41.5XD3 WCM. 06T308	●	41.5	32	44	210	123	150	60	0.8	43.1				
ATUM 42XD3 WCM. 06T308	●	42	32	44	213	126	153	60	0.5	43				
ATUM 42.5XD3 WCM. 06T308	●	42.5	32	44	213	126	153	60	0.5	43.5				
ATUM 43XD3 WCM. 06T308	●	43	32	44	216	129	156	60	0.3	43.6				
ATUM 43.5XD3 WCM. 06T308	●	43.5	32	44	216	129	156	60	0.3	44.1				
ATUM 44XD3 WCM. 06T308	●	44	32	44	219	132	159	60	0	44				
ATUM 44.5XD3 WCM. 06T308	●	44.5	32	44	219	132	159	60	0	44.5				
ATUM 45XD3 WCM. 080412	●	45	40	54	237	135	167	70	3.3	51.6				WCM. 080412
ATUM 45.5XD3 WCM. 080412	●	45.5	40	54	237	135	167	70	3.3	52.1				
ATUM 46XD3 WCM. 080412	●	46	40	54	240	138	170	70	3	52				
ATUM 47XD3 WCM. 080412	●	47	40	54	243	141	173	70	2.8	52.6				
ATUM 48XD3 WCM. 080412	●	48	40	54	246	144	176	70	2.5	53				
ATUM 49XD3 WCM. 080412	●	49	40	54	249	147	179	70	2.2	53.4				
ATUM 50XD3 WCM. 080412	●	50	40	54	252	150	182	70	2	54				
ATUM 51XD3 WCM. 080412	●	51	40	54	255	153	185	70	1.8	54.6				
ATUM 52XD3 WCM. 080412	●	52	40	54	258	156	188	70	1.5	55				
ATUM 53XD3 WCM. 080412	●	53	40	54	261	159	191	70	1.3	55.6				
ATUM 54XD3 WCM. 080412	●	54	40	54	264	162	194	70	1	56				
ATUM 55XD3 WCM. 080412	●	55	40	54	267	165	197	70	0.8	56.6				
ATUM 56XD3 WCM. 080412	●	56	40	64	270	168	200	70	0.5	57				
ATUM 57XD3 WCM. 080412	●	57	40	64	273	171	203	70	0.3	57.6				
ATUM 58XD3 WCM. 080412	●	58	40	64	276	174	206	70	0	58				
ATUM 59XD3 WCM. 080412	●	59	40	64	279	177	209	70	0	59				
ATUM 60XD3 WCM. 080412	●	60	40	64	282	180	212	70	0	60				

R: Sağ / Right / Rechts! L: Sol / Left / Links

● Stokta / In Stock / Auf Lager ○ Stokta Yok / Non Stock Item / Kein Lagerartikel, Lieferzeit auf Anfrage

ISO Ucuna Uygunudur. / Compatible with ISO Insert. / Kompatibel mit ISO Wendeplatten.

Sipariş Örneği/Ordering Example/Bestellbeispiel

1 ad./pcs./stück ATUM 35XD3 WCM. 06T308

Takma Uçlu Matkap Kullanım Kılavuzu : S 375 / User's Guide For U-Drills : P 375

Bedienungsanleitung für Vollbohrer : S 375



Delme Derinliği  
Drilling Depth  
Bohrtiefe

= 4x Çap  
= 4x Diameter  
= 4x Durchmesser

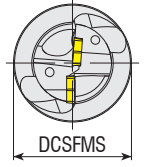
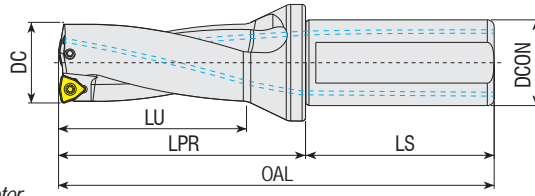

Takım Kodu Ordering Code Bestell-Bezeichnung	Stok Stock Lager	Takım Ölçüleri (mm) Dimension (mm) Abmessung (mm)							Maks. Ofset (radyal) Max. Offset (radial) Max. Versatz (radial)		Kesici Uç Insert Wendeschneidplatte	Yedek Parçaları / Spare Parts / Ersatzteile	
		DC	DCON	DCSFMS	OAL	LU	LPR	LS	X <sub>max</sub> [mm]	DC <sub>max</sub> [mm]		Sıkma Vidası Screw Schraube	Tork Anahtar Torx Key Torx-Schlüssel
ATUM 16XD4 WCM. 030208	●	16	25	34	142	64	86	56	1.5	19	WCM. 030208		
ATUM 16.5XD4 WCM. 030208	○	16.5	25	34	142	64	86	56	1.5	19.5			
ATUM 17XD4 WCM. 030208	●	17	25	34	146	68	90	56	1.5	20			
ATUM 17.5XD4 WCM. 030208	●	17.5	25	34	146	68	90	56	1.5	20.5			
ATUM 18XD4 WCM. 030208	●	18	25	34	150	72	94	56	1.4	20.8			
ATUM 18.5XD4 WCM. 030208	○	18.5	25	34	150	72	94	56	1.3	21.1			
ATUM 19XD4 WCM. 030208	●	19	25	34	154	76	98	56	1.2	21.4			
ATUM 19.5XD4 WCM. 030208	○	19.5	25	34	154	76	98	56	1.2	21.9			
ATUM 20XD4 WCM. 040208	●	20	25	34	158	80	102	56	1.5	23	WCM. 040208	3008-M2.5x6	82-T08
ATUM 20.5XD4 WCM. 040208	○	20.5	25	34	158	80	102	56	1.5	23.5			
ATUM 21XD4 WCM. 040208	●	21	25	34	162	84	106	56	1	23			
ATUM 21.5XD4 WCM. 040208	○	21.5	25	34	162	84	106	56	1	23.5			
ATUM 22XD4 WCM. 040208	●	22	25	34	166	88	110	56	1	24			
ATUM 22.5XD4 WCM. 040208	●	22.5	25	34	166	88	110	56	1	24.5			
ATUM 23XD4 WCM. 040208	●	23	25	34	170	92	114	56	1	25			
ATUM 23.5XD4 WCM. 040208	○	23.5	25	34	170	92	114	56	1	25.5			
ATUM 24XD4 WCM. 050308	●	24	25	34	174	96	118	56	1.4	26.8	WCM. 050308	3008-M3x8	
ATUM 24.5XD4 WCM. 050308	○	24.5	25	34	174	96	118	56	1.4	27.3			
ATUM 25XD4 WCM. 050308	●	25	25	34	178	100	122	56	1.45	27.9			
ATUM 25.5XD4 WCM. 050308	○	25.5	25	34	178	100	122	56	1.45	28.4			
ATUM 26XD4 WCM. 050308	●	26	25	34	182	104	126	56	1.45	28.9			
ATUM 26.5XD4 WCM. 050308	●	26.5	25	34	182	104	126	56	1.45	29.4			
ATUM 27XD4 WCM. 050308	●	27	25	34	186	108	130	56	1.45	29.9			
ATUM 27.5XD4 WCM. 050308	○	27.5	25	34	186	108	130	56	1.45	30.4			
ATUM 28XD4 WCM. 050308	●	28	25	34	190	112	134	56	1.6	31.2			
ATUM 28.5XD4 WCM. 050308	●	28.5	25	34	190	112	134	56	1.6	31.7			
ATUM 29XD4 WCM. 050308	●	29	25	34	194	116	138	56	1.65	32.3			
ATUM 29.5XD4 WCM. 050308	○	29.5	25	34	194	116	138	56	1.65	32.8			

R: Sağ / Right / Rechts / L: Sol / Left / Links

● Stokta / In Stock / Auf Lager ○ Stokta Yok / Non Stock Item / Kein Lagerartikel, Lieferzeit auf Anfrage  
ISO Uçuna Uygundur. / Compatible with ISO Insert. / Kompatibel mit ISO Wendeplatten.

Sipariş Örneği/Ordering Example/Bestellbeispiel

1 ad./pcs./stück ATUM 16XD4 WCM. 030208

Takma Uçlu Matkap Kullanım Kılavuzu : S 375 / User's Guide For U-Drills : P 375

Bedienungsanleitung für Vollbohrer : S 375



Delme Derinliği  
Drilling Depth  
Bohrtiefe = 4x Çap  
= 4x Diameter  
= 4x Durchmesser

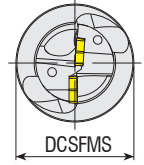
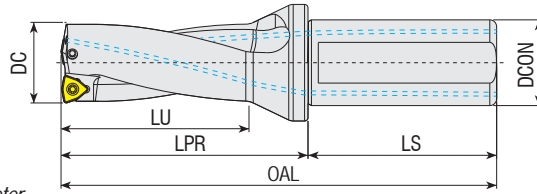

Takım Kodu Ordering Code Bestell-Bezeichnung	Stok Stock Lager	Takım Ölçüleri (mm) Dimension (mm) Abmessung (mm)							Maks. Ofset (radyal) Max. Offset (radial) Max. Versatz (radial)		Kesici Uç Insert Wendescheidplatte	Yedek Parçaları / Spare Parts / Ersatzteile	
		DC	DCON	DCSFMS	OAL	LU	LPR	LS	X <sub>max</sub>	DC <sub>max</sub>		Sıkma Vidası Screw Schraube	Tork Anahtar Torx Key Torx-Schlüssel
ATUM 30XD4 WCM. 06T308	●	30	32	44	207	120	147	60	2.4	34.8	WCM. 06T308	3010-M3.5x9	82-T10
ATUM 31XD4 WCM. 06T308	●	31	32	44	211	124	151	60	2.3	35.6			
ATUM 32XD4 WCM. 06T308	●	32	32	44	215	128	155	60	2.1	36.2			
ATUM 33XD4 WCM. 06T308	●	33	32	44	219	132	159	60	1.9	36.8			
ATUM 33.5XD4 WCM. 06T308	●	33.5	32	44	219	132	159	60	1.9	37.3			
ATUM 34XD4 WCM. 06T308	●	34	32	44	223	136	163	60	1.9	37.8			
ATUM 35XD4 WCM. 06T308	●	35	32	44	227	140	167	60	1.9	38.8			
ATUM 36XD4 WCM. 06T308	●	36	32	44	231	144	171	60	2	40			
ATUM 37XD4 WCM. 06T308	●	37	32	44	235	148	175	60	1.8	40.6			
ATUM 38XD4 WCM. 06T308	●	38	32	44	239	152	179	60	1.5	41			
ATUM 38.5XD4 WCM. 06T308	●	38.5	32	44	239	152	179	60	1.5	41.5			
ATUM 39XD4 WCM. 06T308	●	39	32	44	243	156	183	60	1.3	41.6			
ATUM 40XD4 WCM. 06T308	●	40	32	44	247	160	187	60	1	42			
ATUM 41XD4 WCM. 06T308	●	41	32	44	251	164	191	60	0.8	42.6			
ATUM 42XD4 WCM. 06T308	●	42	32	44	255	168	195	60	0.5	43			
ATUM 43XD4 WCM. 06T308	●	43	32	44	259	172	199	60	0.3	43.6			
ATUM 44XD4 WCM. 06T308	●	44	32	44	263	176	203	60	0	44			
ATUM 45XD4 WCM. 080412	●	45	40	54	282	180	212	70	3.3	51.6	WCM. 080412	4015-M4x11	80-T15
ATUM 46XD4 WCM. 080412	●	46	40	54	286	184	216	70	3	52			
ATUM 47XD4 WCM. 080412	●	47	40	54	290	188	220	70	2.8	52.6			
ATUM 48XD4 WCM. 080412	●	48	40	54	294	192	224	70	2.5	53			
ATUM 49XD4 WCM. 080412	●	49	40	54	298	196	228	70	2.2	53.4			
ATUM 50XD4 WCM. 080412	●	50	40	54	302	200	232	70	2	54			

R: Sağ / Right / Rechts L: Sol / Left / Links

● Stokta / In Stock / Auf Lager ○ Stokta Yok / Non Stock Item / Kein Lagerartikel, Lieferzeit auf Anfrage  
ISO Ucuna Uygundur. / Compatible with ISO Insert. / Kompatibel mit ISO Wendeplatten.

Sipariş Örneği/Ordering Example/Bestellbeispiel

1 ad./pcs./stück ATUM 30XD4 WCM. 06T308

Takma Uçlu Matkap Kullanım Kılavuzu : S 375 / User's Guide For U-Drills : P 375

Bedienungsanleitung für Vollbohrer : S 375



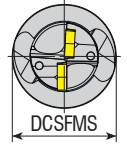
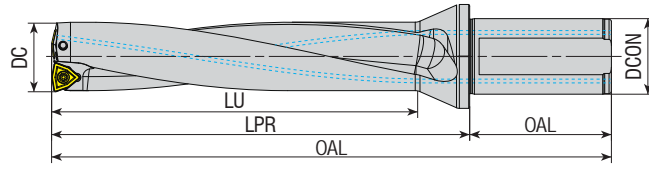

Delme Derinliği  
Drilling Depth  
Bohrtiefe

= 5x Çap  
= 5x Diameter  
= 5x Durchmesser

**Takım Kodu**  
**Ordering Code**  
**Bestell-Bezeichnung**

Stok Stock Lager	Takım Ölçüleri (mm) Dimension (mm) Abmessung (mm)							Maks. Ofset (radyal) Max. Offset (radial) Max. Versatz (radial)		Kesici Uç Insert Wendeschneidplatte	Yedek Parçaları / Spare Parts / Ersatzteile		
	DC	DCON	DCSFMS	OAL	LU	LPR	LS	X <sub>max</sub>	DC <sub>max</sub> [mm]		Sıkma Vidası Screw Schraube	Tork Anahtar Torx Key Torx-Schlüssel	
ATUM 20XD5 WCM. 040208	●	20	25	34	178	100	122	56	1.5	23	WCM. 040208	3008-M2.5x6	
ATUM 21XD5 WCM. 040208	●	21	25	34	183	105	127	56	1	23			
ATUM 22XD5 WCM. 040208	●	22	25	34	188	110	132	56	1	24			
ATUM 23XD5 WCM. 040208	●	23	25	34	193	115	137	56	1	25			
ATUM 24XD5 WCM. 050308	●	24	25	34	198	120	142	56	1.4	26.8	WCM. 050308	3008-M3x8	82-T08
ATUM 25XD5 WCM. 050308	●	25	25	34	203	125	147	56	1.45	27.9			
ATUM 26XD5 WCM. 050308	●	26	25	34	208	130	152	56	1.45	28.9			
ATUM 27XD5 WCM. 050308	●	27	25	34	213	135	157	56	1.45	29.9			
ATUM 28XD5 WCM. 050308	●	28	25	34	218	140	162	56	1.6	31.2			
ATUM 29XD5 WCM. 050308	●	29	25	34	223	145	167	56	1.65	32.3			
ATUM 30XD5 WCM. 06T308	●	30	32	44	237	150	177	60	2.4	34.8	WCM. 06T308	3010-M3.5x9	82-T10
ATUM 31XD5 WCM. 06T308	●	31	32	44	242	155	182	60	2.3	35.6			
ATUM 32XD5 WCM. 06T308	●	32	32	44	247	160	187	60	2.1	36.2			
ATUM 33XD5 WCM. 06T308	●	33	32	44	252	165	192	60	1.9	36.8			
ATUM 34XD5 WCM. 06T308	●	34	32	44	257	170	197	60	1.9	37.8			
ATUM 35XD5 WCM. 06T308	●	35	32	44	262	175	202	60	1.9	38.8			
ATUM 37XD5 WCM. 06T308	●	37	32	44	272	185	212	60	1.8	40.6			
ATUM 38XD5 WCM. 06T308	●	38	32	44	277	190	217	60	1.5	41			
ATUM 46XD5 WCM. 080412	●	46	40	54	332	230	262	70	3	52	WCM. 080412	4015-M4x11	80-T15

R: Sağ / Right / Rechts/ L: Sol / Left / Links  
● Stokta / In Stock / Auf Lager ○ Stokta Yok / Non Stock Item / Kein Lagerartikel, Lieferzeit auf Anfrage  
ISO Ucuna Uygun. / Compatible with ISO Insert. / Kompatibel mit ISO Wendeplatten.

Sipariş Örneği/Ordering Example/Bestellbeispiel  
1 ad./pcs./stück ATUM 20XD5 WCM. 040208

Takma Uçlu Matkap Kullanım Kılavuzu : S 375 / User's Guide For U-Drills : P 375  
Bedienungsanleitung für Vollbohrer : S 375



Delme Derinliği  
Drilling Depth  
Bohrtiefe

= 2x Çap  
= 2x Diameter  
= 2x Durchmesser

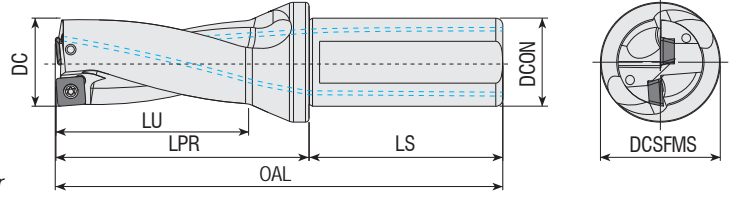

**Takım Kodu**  
**Ordering Code**  
**Bestell-Bezeichnung**

Stok  
Stock  
Lager

Takım Ölçüleri (mm)  
Dimension (mm)  
Abmessung (mm)

Maks. Ofset (radyal)  
Max. Offset (radial)  
Max. Versatz (radial)

Kesici Uç  
Insert  
Wendeschnidplatte

Yedek Parçaları / Spare Parts / Ersatzteile

Sıkma Vidası  
Screw  
Schraube

Tork Anahtar  
Torx Key  
Torx-Schlüssel

DC

DCON

DCSFMS

OAL

LU

LPR

LS

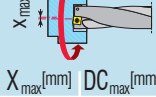

ATUM	SP.	Ordering Code	Stok	DC	DCON	DCSFMS	OAL	LU	LPR	LS	X <sub>max</sub>	DC <sub>max</sub>	SP.	Sıkma Vidası	Tork Anahtar
ATUM 12.5XD2	SP. 050204	●	12.5	20	25	96	24	46	50	0.75	14	SP. 050204	3006-M2x4	82-T06	
ATUM 13XD2	SP. 050204	●	13	20	25	98	26	48	50	0.75	14.5				
ATUM 13.5XD2	SP. 050204	●	13.5	20	25	98	26	48	50	0.75	15				
ATUM 14XD2	SP. 050204	●	14	20	25	100	28	50	50	0.6	15.2				
ATUM 14.5XD2	SP. 050204	●	14.5	20	25	100	28	50	50	0.6	15.7				
ATUM 15XD2	SP. 050204	●	15	20	25	102	30	52	50	0.5	16				
ATUM 15.5XD2	SP. 060204	●	15.5	20	25	102	30	52	50	0.9	17.3	SP. 060204	3007-M2.2x4.6	82-T07	
ATUM 16XD2	SP. 060204	●	16	25	34	110	32	54	56	0.8	17.6				
ATUM 16.5XD2	SP. 060204	●	16.5	25	34	110	32	54	56	0.8	18.1				
ATUM 17XD2	SP. 060204	●	17	25	34	112	34	56	56	0.75	18.5				
ATUM 17.5XD2	SP. 060204	●	17.5	25	34	112	34	56	56	0.75	19				
ATUM 18XD2	SP. 060204	●	18	25	34	114	36	58	56	0.5	19				
ATUM 18.5XD2	SP. 060204	●	18.5	25	34	114	36	58	56	0.5	19.5				
ATUM 19XD2	SP. 060204	●	19	25	34	116	38	60	56	0.3	19.6				
ATUM 19.5XD2	SP. 060204	●	19.5	25	34	116	38	60	56	0.3	20.1				
ATUM 20XD2	SP. 060204	●	20	25	34	118	40	62	56	0	20				
ATUM 20.5XD2	SP. 060204	●	20.5	25	34	118	40	62	56	0	20.5				
ATUM 21XD2	SP. 060204	●	21	25	34	120	42	64	56	0	21				
ATUM 21.5XD2	SP. 060204	●	21.5	25	34	120	42	64	56	0	21.5				
ATUM 22XD2	SP. 07T308	●	22	25	34	122	44	66	56	1	24	SP. 07T308	3008-M2.5x6	82-T08	
new ATUM 22XD2	SP. 07T308-32	●	22	32	44	131	44	71	60	1	24				
ATUM 22.5XD2	SP. 07T308	●	22.5	25	34	122	44	66	56	1	24.5				
ATUM 23XD2	SP. 07T308	●	23	25	34	124	46	68	56	0.75	24.5				
new ATUM 23XD2	SP. 07T308-32	●	23	32	44	133	46	73	60	0.75	24.5				
ATUM 23.5XD2	SP. 07T308	●	23.5	25	34	124	46	68	56	0.75	25				
ATUM 24XD2	SP. 07T308	●	24	25	34	126	48	70	56	0.5	25				
new ATUM 24XD2	SP. 07T308-32	●	24	32	44	135	48	75	60	0.50	25				
ATUM 24.5XD2	SP. 07T308	●	24.5	25	34	126	48	70	56	0.5	25.5				
ATUM 25XD2	SP. 07T308	●	25	25	34	128	50	72	56	0.25	25.5				
new ATUM 25XD2	SP. 07T308-32	●	25	32	44	137	50	77	60	0.25	25.5				
ATUM 25.5XD2	SP. 07T308	●	25.5	25	34	128	50	72	56	0.25	26				
ATUM 26XD2	SP. 07T308	●	26	25	34	130	52	74	56	0	26				
new ATUM 26XD2	SP. 07T308-32	●	26	32	44	139	52	79	60	0	26				
ATUM 26.5XD2	SP. 07T308	●	26.5	25	34	130	52	74	56	0	26.5				
ATUM 27XD2	SP. 07T308	●	27	25	34	132	54	76	56	0	27				
new ATUM 27XD2	SP. 07T308-32	●	27	32	44	141	54	81	60	0	27				
ATUM 27.5XD2	SP. 07T308	●	27.5	25	34	132	54	76	56	0	27.5				

R: Sağ / Right / Rechts/ L: Sol / Left / Links

● Stokta / In Stock / Auf Lager ○ Stokta Yok / Non Stock Item / Kein Lagerartikel, Lieferzeit auf Anfrage  
TGTC Ucuna Uygunudur. / Compatible with TGTC Insert. / Kompatibel mit TGTC Wendeplatten.

Sipariş Örneği/Ordering Example/Bestellbeispiel

1 ad./pcs./stück ATUM 12.5XD2 SP. 050204

Takma Uçlu Matkap Kullanım Kılavuzu : S 375 / User's Guide For U-Drills : P 375

Bedienungsanleitung für Vollbohrer : S 375



Delme Derinliği  
Drilling Depth  
Bohrtiefe  
= 2x Çap  
= 2x Diameter  
= 2x Durchmesser

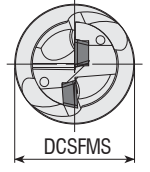
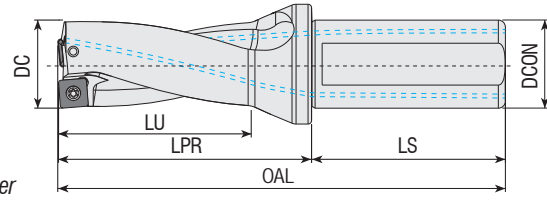

Takım Kodu Ordering Code Bestell-Bezeichnung	Stok Stock Lager	Takım Ölçüleri (mm) Dimension (mm) Abmessung (mm)							Maks. Ofset (radyal) Max. Offset (radial) Max. Versatz (radial)		Kesici Uç Insert Wendeschneidplatte	Yedek Parçaları / Spare Parts / Ersatzteile	
		DC	DCON	DCSFMS	OAL	LU	LPR	LS	X <sub>max</sub> X <sub>max</sub> (mm)	DC <sub>max</sub> DC <sub>max</sub> (mm)		Sıkma Vidası Screw Schraube	Tork Anahtar Torx Key Torx-Schlüssel
ATUM 28XD2 SP. 090408	●	28	25	34	134	56	78	56	1	30	SP. 090408	4015-M3.5x9	80-T15
new ATUM 28XD2 SP. 090408-32	●	28	32	44	143	56	83	60	1	29			
ATUM 28.5XD2 SP. 090408	●	28.5	25	34	134	56	78	56	1	30.5			
ATUM 29XD2 SP. 090408	●	29	25	34	136	58	80	56	0.75	30.5			
new ATUM 29XD2 SP. 090408-32	●	29	32	44	145	58	85	60	0.75	30.5			
ATUM 29.5XD2 SP. 090408	●	29.5	25	34	136	58	80	56	0.75	31			
ATUM 30XD2 SP. 090408	●	30	32	44	147	60	87	60	0.5	31			
ATUM 31XD2 SP. 090408	●	31	32	44	149	62	89	60	0.25	31.5			
ATUM 32XD2 SP. 090408	●	32	32	44	151	64	91	60	0	32	SP. 110408	4015-M4x11	80-T15
ATUM 33XD2 SP. 090408	●	33	32	44	153	66	93	60	0	33			
ATUM 34XD2 SP. 110408	●	34	32	44	155	68	95	60	1	36			
ATUM 35XD2 SP. 110408	●	35	32	44	157	70	97	60	0.75	36.5			
ATUM 36XD2 SP. 110408	●	36	32	44	159	72	99	60	0.6	37.2			
ATUM 37XD2 SP. 110408	●	37	32	44	161	74	101	60	0.5	38			
ATUM 38XD2 SP. 110408	●	38	32	44	163	76	103	60	0.25	38.5			
ATUM 39XD2 SP. 110408	●	39	32	44	165	78	105	60	0	39			
ATUM 40XD2 SP. 110408	●	40	32	44	167	80	107	60	0	40	SP. 140512	1020-M5x11	80-T20
ATUM 41XD2 SP. 110408	●	41	32	44	169	82	109	60	0	41			
ATUM 42XD2 SP. 140512	●	42	32	44	171	84	111	60	1.2	44.4			
ATUM 43XD2 SP. 140512	●	43	32	44	173	86	113	60	1	45			
ATUM 44XD2 SP. 140512	●	44	32	44	175	88	115	60	0.8	45.6			
ATUM 45XD2 SP. 140512	●	45	40	54	192	90	122	70	0.6	46.2			
ATUM 46XD2 SP. 140512	●	46	40	54	194	92	124	70	0.4	46.8			
ATUM 47XD2 SP. 140512	●	47	40	54	196	94	126	70	0.2	47.4			
ATUM 48XD2 SP. 140512	●	48	40	54	198	96	128	70	0	48			
ATUM 49XD2 SP. 140512	●	49	40	54	200	98	130	70	0	49			
ATUM 50XD2 SP. 140512	●	50	40	54	202	100	132	70	0	50			

R: Sağ / Right / Rechts/ L: Sol / Left / Links

● Stokta / In Stock / Auf Lager ○ Stokta Yok / Non Stock Item / Kein Lagerartikel, Lieferzeit auf Anfrage  
TGTC Ucuna Uygundur. / Compatible with TGTC Insert. / Kompatibel mit TGTC Wendeplatten.

Sipariş Örneği/Ordering Example/Bestellbeispiel

1 ad./pcs./stück ATUM 28XD2 SP. 090408

Takma Uçlu Matkap Kullanım Kılavuzu : S 375 / User's Guide For U-Drills : P 375

Bedienungsanleitung für Vollbohrer : S 375



Delme Derinliği  
Drilling Depth  
Bohrtiefe = 3x Çap  
= 3x Diameter  
= 3x Durchmesser

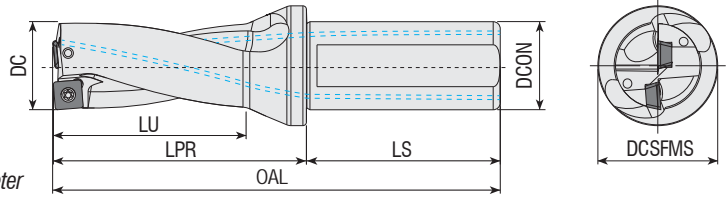

Takım Kodu  
Ordering Code  
Bestell-Bezeichnung

Stok  
Stock  
Lager

Takım Ölçüleri (mm)  
Dimension (mm)  
Abmessung (mm)

Maks. Offset (radyal)  
Max. Offset (radial)  
Max. Versatz (radial)

Kesici Uç  
Insert  
Wendescheidplatte

Yedek Parçaları / Spare Parts / Ersatzteile

Sıkma Vidası  
Screw  
Schraube

Tork Anahtar  
Torx Key  
Torx-Schlüssel

DC

DCON

DCSFMS

OAL

LU

LPR

LS

X<sub>max</sub>

X<sub>max</sub> [mm]

DC<sub>max</sub>

DC<sub>max</sub> [mm]

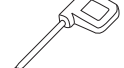

ATUM	DC	DCON	DCSFMS	OAL	LU	LPR	LS	X <sub>max</sub>	DC <sub>max</sub>	SP.	Sıkma Vidası	Tork Anahtar
12.5XD3 SP. 050204	12.5	20	25	108	36	58	50	0.75	14	SP. 050204	3006-M2x4	82-T06
13XD3 SP. 050204	13	20	25	111	39	61	50	0.75	14.5			
13.5XD3 SP. 050204	13.5	20	25	111	39	61	50	0.75	15			
14XD3 SP. 050204	14	20	25	114	42	64	50	0.6	15.2			
14.5XD3 SP. 050204	14.5	20	25	114	42	64	50	0.6	15.7			
15XD3 SP. 050204	15	20	25	117	45	67	50	0.5	16			
15.5XD3 SP. 060204	15.5	20	25	117	45	67	50	0.9	17.3			
16XD3 SP. 060204	16	25	34	126	48	70	56	0.8	17.6			
16.5XD3 SP. 060204	16.5	25	34	126	48	70	56	0.8	18.1			
17XD3 SP. 060204	17	25	34	129	51	73	56	0.75	18.5			
17.5XD3 SP. 060204	17.5	25	34	129	51	73	56	0.75	19			
18XD3 SP. 060204	18	25	34	132	54	76	56	0.5	19			
18.5XD3 SP. 060204	18.5	25	34	132	54	76	56	0.5	19.5			
19XD3 SP. 060204	19	25	34	135	57	79	56	0.3	19.6			
19.5XD3 SP. 060204	19.5	25	34	135	57	79	56	0.3	20.1			
20XD3 SP. 060204	20	25	34	138	60	82	56	0	20			
20.5XD3 SP. 060204	20.5	25	34	138	60	82	56	0	20.5			
21XD3 SP. 060204	21	25	34	141	63	85	56	0	21			
21.5XD3 SP. 060204	21.5	25	34	141	63	85	56	0	21.5			
22XD3 SP. 07T308	22	25	34	144	66	88	56	1	24			
new 22XD3 SP. 07T308-32	22	32	44	153	66	93	60	1	23			
22.5XD3 SP. 07T308	22.5	25	34	144	66	88	56	1	24.5			
23XD3 SP. 07T308	23	25	34	147	69	91	56	0.75	24.5			
new 23XD3 SP. 07T308-32	23	32	44	156	69	96	60	0.75	24.5			
23.5XD3 SP. 07T308	23.5	25	34	147	69	91	56	0.75	25			
24XD3 SP. 07T308	24	25	34	150	72	94	56	0.5	25			
new 24XD3 SP. 07T308-32	24	32	44	159	72	99	60	0.50	25			
24.5XD3 SP. 07T308	24.5	25	34	150	72	94	56	0.5	25.5			
25XD3 SP. 07T308	25	25	34	153	75	97	56	0.25	25.5			
new 25XD3 SP. 07T308-32	25	32	44	162	75	102	60	0.25	25.5			
25.5XD3 SP. 07T308	25.5	25	34	153	75	97	56	0.25	26			
26XD3 SP. 07T308	26	25	34	156	78	100	56	0	26			
new 26XD3 SP. 07T308-32	26	32	44	165	78	105	60	0	26			
26.5XD3 SP. 07T308	26.5	25	34	156	78	100	56	0	26.5			
27XD3 SP. 07T308	27	25	34	159	81	103	56	0	27			
new 27XD3 SP. 07T308-32	27	32	44	168	81	108	60	0	27			
27.5XD3 SP. 07T308	27.5	25	34	159	81	103	56	0	27.5			
28XD3 SP. 090408	28	25	34	162	84	106	56	1	30			
new 28XD3 SP. 090408-32	28	32	44	171	84	111	60	1	29			
28.5XD3 SP. 090408	28.5	25	34	162	84	106	56	1	30.5			
29XD3 SP. 090408	29	25	34	165	87	109	56	0.75	30.5			
new 29XD3 SP. 090408-32	29	32	44	174	87	114	6	0.75	30.5			
29.5XD3 SP. 090408	29.5	25	34	165	87	109	56	0.75	31			
30XD3 SP. 090408	30	32	44	177	90	117	60	0.5	31			
30.5XD3 SP. 090408	30.5	32	44	177	90	117	60	0.5	31.5			
31XD3 SP. 090408	31	32	44	180	93	120	60	0.25	31.5			
31.5XD3 SP. 090408	31.5	32	44	180	93	120	60	0.25	32			
32XD3 SP. 090408	32	32	44	183	96	123	60	0	32			
32.5XD3 SP. 090408	32.5	32	44	183	96	123	60	0	32.5			
33XD3 SP. 090408	33	32	44	186	99	126	60	0	33			
33.5XD3 SP. 090408	33.5	32	44	186	99	126	60	0	33.5			

R: Sağ / Right / Rechtsl L: Sol / Left / Links

● Stokta / In Stock / Auf Lager ○ Stokta Yok / Non Stock Item / Kein Lagerartikel, Lieferzeit auf Anfrage

TGTC Ucuna Uygundur. / Compatible with TGTC Insert. / Kompatibel mit TGTC Wendeplatten.

Sipariş Örneği/Ordering Example/Bestellbeispiel

1 ad./pcs./stück ATUM 12.5XD3 SP. 050204

Takma Uçlu Matkap Kullanım Kılavuzu : S 375 / User's Guide For U-Drills : P 375

Bedienungsanleitung für Vollbohrer : S 375



Delme Derinliği  
Drilling Depth  
Bohrtiefe = 3x Çap  
= 3x Diameter  
= 3x Durchmesser

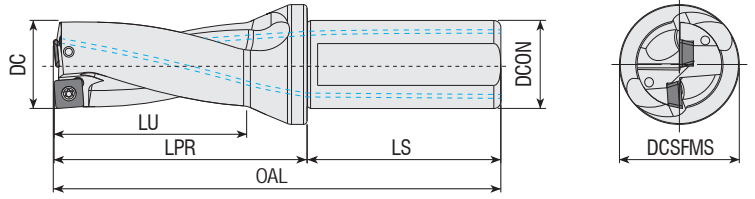

Takım Kodu  
Ordering Code  
Bestell-Bezeichnung

Takım Kodu Ordering Code Bestell-Bezeichnung	Stok Stock Lager	Takım Ölçüleri (mm) Dimension (mm) Abmessung (mm)							Maks. Ofset (radyal) Max. Offset (radial) Max. Versatz (radial)		Kesici Uç Insert Wendeschneidplatte	Yedek Parçaları / Spare Parts / Ersatzteile	
		DC	DCON	DCSFMS	OAL	LU	LPR	LS	X <sub>max</sub>	DC <sub>max</sub> [mm]		Sıkma Vidası Screw Schraube	Tork Anahtar Torx Key Torx-Schlüssel
ATUM 34XD3 SP. 110408	●	34	32	44	189	102	129	60	1	36	SP. 110408	4015-M4x11	80-T15
ATUM 34.5XD3 SP. 110408	●	34.5	32	44	189	102	129	60	1	36.5			
ATUM 35XD3 SP. 110408	●	35	32	44	192	105	132	60	0.75	36.5			
ATUM 35.5XD3 SP. 110408	●	35.5	32	44	192	105	132	60	0.75	37			
ATUM 36XD3 SP. 110408	●	36	32	44	195	108	135	60	0.6	37.2			
ATUM 36.5XD3 SP. 110408	●	36.5	32	44	195	108	135	60	0.6	37.7			
ATUM 37XD3 SP. 110408	●	37	32	44	198	111	138	60	0.5	38			
ATUM 37.5XD3 SP. 110408	●	37.5	32	44	198	111	138	60	0.5	38.5			
ATUM 38XD3 SP. 110408	●	38	32	44	201	114	141	60	0.25	38.5			
ATUM 38.5XD3 SP. 110408	●	38.5	32	44	201	114	141	60	0.25	39			
ATUM 39XD3 SP. 110408	●	39	32	44	204	117	144	60	0	39			
ATUM 39.5XD3 SP. 110408	●	39.5	32	44	204	117	144	60	0	39.5			
ATUM 40XD3 SP. 110408	●	40	32	44	207	120	147	60	0	40			
ATUM 40.5XD3 SP. 110408	●	40.5	32	44	207	120	147	60	0	40.5			
ATUM 41XD3 SP. 110408	●	41	32	44	210	123	150	60	0	41			
ATUM 41.5XD3 SP. 110408	●	41.5	32	44	210	123	150	60	0	41.5			
ATUM 42XD3 SP. 140512	●	42	32	44	213	126	153	60	1.2	44.4	SP. 140512	1020-M5x11	80-T20
ATUM 42.5XD3 SP. 140512	●	42.5	32	44	213	126	153	60	1.2	44.9			
ATUM 43XD3 SP. 140512	●	43	32	44	216	129	156	60	1	45			
ATUM 43.5XD3 SP. 140512	●	43.5	32	44	216	129	156	60	1	45.5			
ATUM 44XD3 SP. 140512	●	44	32	44	219	132	159	60	0.8	45.6			
ATUM 44.5XD3 SP. 140512	●	44.5	32	44	219	132	159	60	0.8	46.1			
ATUM 45XD3 SP. 140512	●	45	40	54	237	135	167	70	0.6	46.2			
ATUM 45.5XD3 SP. 140512	●	45.5	40	54	237	135	167	70	0.6	46.7			
ATUM 46XD3 SP. 140512	●	46	40	54	240	138	170	70	0.4	46.8			
ATUM 47XD3 SP. 140512	●	47	40	54	243	141	173	70	0.2	47.4			
ATUM 48XD3 SP. 140512	●	48	40	54	246	144	176	70	0	48			
ATUM 49XD3 SP. 140512	●	49	40	54	249	147	179	70	0	49			
ATUM 50XD3 SP. 140512	●	50	40	54	252	150	182	70	0	50			
ATUM 51XD3 SP. 140512	●	51	40	54	255	153	185	70	0	51			
ATUM 52XD3 SP. 140512	●	52	40	54	258	156	188	70	0	52			

R: Sağ / Right / Rechts/ L: Sol / Left / Links  
● Stokta / In Stock / Auf Lager ○ Stokta Yok / Non Stock Item / Kein Lagerartikel, Lieferzeit auf Anfrage  
TGTC Ucuna Uygunur. / Compatible with TGTC Insert. / Kompatibel mit TGTC Wendeplatten.

Sipariş Örneği/Ordering Example/Bestellbeispiel  
1 ad./pcs./stück ATUM 34XD3 SP. 110408  
Takma Uçlu Matkap Kullanım Kılavuzu : S 375 / User's Guide For U-Drills : P 375  
Bedienungsanleitung für Vollbohrer : S 375





Delme Derinliği  
Drilling Depth  
Bohrtiefe

= 4x Çap  
= 4x Diameter  
= 4x Durchmesser

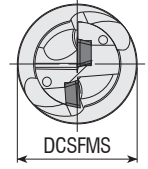
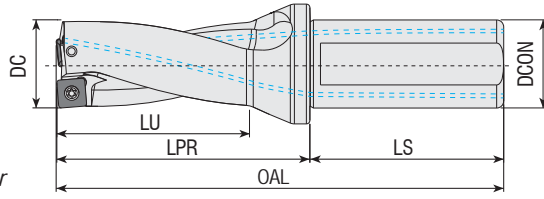

Takım Kodu  
Ordering Code  
Bestell-Bezeichnung

Stok  
Stock  
Lager

Takım Ölçüleri (mm)  
Dimension (mm)  
Abmessung (mm)

Maks. Ofset (radyal)  
Max. Offset (radial)  
Max. Versatz (radial)

Kesici Uç  
Insert  
Wendeschneidplatte

Yedek Parçaları / Spare Parts / Ersatzteile

Sıkma Vidası  
Screw  
Schraube

Tork Anahtar  
Torx Key  
Torx-Schlüssel

ATUM	Model	SP.	Part No	Stok Durumu	DC	DCON	DCSFMS	OAL	LU	LPR	LS	Maks. Ofset (radyal)		Kesici Uç	Sıkma Vidası	Tork Anahtar	
												X <sub>max</sub>	DC <sub>max</sub>				
													X <sub>max</sub> [mm]	DC <sub>max</sub> [mm]			
	13XD4	SP.	050204	●	13	20	25	124	52	74	50	0.75	14.5	SP. 050204	3006-M2x4	82-T06	
	14XD4	SP.	050204	●	14	20	25	128	56	78	50	0.6	15.2				
new	14.5XD4	SP.	050204	●	14.5	20	25	128	56	78	50	0.60	15.7				
	15XD4	SP.	050204	●	15	20	25	132	60	82	50	0.5	16				
	16XD4	SP.	060204	●	16	25	34	142	64	86	56	0.8	17.6	SP. 060204	3007-M2.2x4.6	82-T07	
	17XD4	SP.	060204	●	17	25	34	146	68	90	56	0.75	18.5				
	17.5XD4	SP.	060204	●	17.5	25	34	146	68	90	56	0.75	19				
	18XD4	SP.	060204	●	18	25	34	150	72	94	56	0.5	19				
	19XD4	SP.	060204	●	19	25	34	154	76	98	56	0.3	19.6				
	19.5XD4	SP.	060204	●	19.5	25	34	154	76	98	56	0.3	20.1				
	20XD4	SP.	060204	●	20	25	34	158	80	102	56	0	20				
	21XD4	SP.	060204	●	21	25	34	162	84	106	56	0	21				
	22XD4	SP.	07T308	●	22	25	34	166	88	110	56	1	24	SP. 07T308	3008-M2.5x6	82-T08	
	23XD4	SP.	07T308	●	23	25	34	170	92	114	56	0.75	24.5				
	23.5XD4	SP.	07T308	●	23.5	25	34	170	92	114	56	0.75	25				
	24XD4	SP.	07T308	●	24	25	34	174	96	118	56	0.5	25				
	25XD4	SP.	07T308	●	25	25	34	178	100	122	56	0.25	25.5				
	26XD4	SP.	07T308	●	26	25	34	182	104	126	56	0	26				
	27XD4	SP.	07T308	●	27	25	34	186	108	130	56	0	27				
	27.5XD4	SP.	07T308	●	27.5	25	34	186	108	130	56	0	27.5				
	28XD4	SP.	090408	●	28	25	34	190	112	134	56	1	30	SP. 090408	4015-M3.5x9	80-T15	
	29XD4	SP.	090408	●	29	25	34	194	116	138	56	0.75	30.5				
	30XD4	SP.	090408	●	30	32	44	207	120	147	60	0.5	31				
	31XD4	SP.	090408	●	31	32	44	211	124	151	60	0.25	31.5				
	32XD4	SP.	090408	●	32	32	44	215	128	155	60	0	32				
	33XD4	SP.	090408	●	33	32	44	219	132	159	60	0	33				
	33.5XD4	SP.	090408	●	33.5	32	44	219	132	159	60	0	33.5				
	34XD4	SP.	110408	●	34	32	44	223	136	163	60	1	36				
	35XD4	SP.	110408	●	35	32	44	227	140	167	60	0.75	36.5	SP. 110408	4015-M4x11	80-T15	
	36XD4	SP.	110408	●	36	32	44	231	144	171	60	0.6	37.2				
	37XD4	SP.	110408	●	37	32	44	235	148	175	60	0.5	38				
	38XD4	SP.	110408	●	38	32	44	239	152	179	60	0.25	38.5				
	39XD4	SP.	110408	●	39	32	44	243	156	183	60	0	39				
	40XD4	SP.	110408	●	40	32	44	247	160	187	60	0	40				
	41XD4	SP.	110408	●	41	32	44	251	164	191	60	0	41				
	42XD4	SP.	140512	●	42	32	44	255	168	195	60	1.2	44.4				
	43XD4	SP.	140512	●	43	32	44	259	172	199	60	1	45	SP. 140512	1020-M5x11	80-T20	
	44XD4	SP.	140512	●	44	32	44	263	176	203	60	0.8	45.6				
new	46XD4	SP.	140512	●	46	40	54	286	184	216	70	0.40	46.8				

R: Sağ / Right / Rechtsl L: Sol / Left / Links

● Stokta / In Stock / Auf Lager ○ Stokta Yok / Non Stock Item / Kein Lagerartikel, Lieferzeit auf Anfrage  
TGTC Ucuna Uygun. / Compatible with TGTC Insert. / Kompatibel mit TGTC Wendeplatten.

Sipariş Örneği/Ordering Example/Bestellbeispiel

1 ad./pcs./stück ATUM 13XD4 SP. 050204

Takma Uçlu Matkap Kullanım Kılavuzu : S 375 / User's Guide For U-Drills : P 375

Bedienungsanleitung für Vollbohrer : S 375

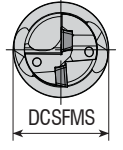
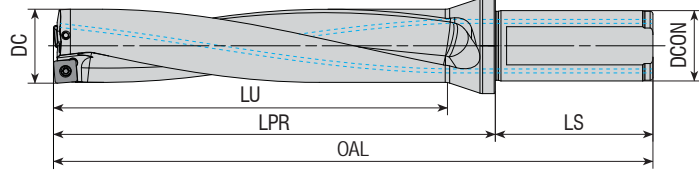

Delme Derinliği  
Drilling Depth  
Bohrtiefe

= 5x Çap  
= 5x Diameter  
= 5x Durchmesser

Takım Kodu Ordering Code Bestell-Bezeichnung	Stok Stock Lager	Takım Ölçüleri (mm) Dimension (mm) Abmessung (mm)							Maks. Ofset (radyal) Max. Offset (radial) Max. Versatz (radial)		Kesici Uç Insert Wendeschneidplatte	Yedek Parçaları / Spare Parts / Ersatzteile	
		DC	DCON	DCSFMS	OAL	LU	LPR	LS	$X_{max}$ [mm]	$DC_{max}$ [mm]		Sikma Vidası Screw Schraube	Tork Anahtar Torx Key Torx-Schlüssel
<b>new</b> ATUM 13XD5 SP. 050204	●	13	20	25	137	65	87	50	0.75	14.5	SP. 050204	3006-M2.5x4	82-T06
ATUM 14XD5 SP. 050204	●	14	20	25	142	70	92	50	0.6	15.2			
<b>new</b> ATUM 14.5XD5 SP. 050204	●	14.5	20	25	142	70	92	50	0.60	15.7			
<b>new</b> ATUM 15XD5 SP. 050204	●	15	20	25	147	75	97	50	0.50	16	SP. 060204	3006-M2.5x4	82-T07
ATUM 16XD5 SP. 060204	●	16	25	34	158	80	102	56	0.8	17.6			
ATUM 17XD5 SP. 060204	●	17	25	34	163	85	107	56	0.75	18.5			
<b>new</b> ATUM 17XD5 SP. 060204-32	●	17	32	34	163	85	107	56	0.75	18.5	SP. 060204	3007-M2.2x4.6 3007-M2.2x5	82-T07
ATUM 18XD5 SP. 060204	●	18	25	34	168	90	112	56	0.5	19			
ATUM 19XD5 SP. 060204	●	19	25	34	173	95	117	56	0.3	19.6			
ATUM 20XD5 SP. 060204	●	20	25	34	178	100	122	56	0	20	SP. 07T308	3008-M2.5x6	82-T08
ATUM 21XD5 SP. 060204	●	21	25	34	183	105	127	56	0	21			
ATUM 22XD5 SP. 07T308	●	22	25	34	188	110	132	56	1	24			
ATUM 22XD5 SP. 07T308-32	●	22	32	44	197	110	137	60	1	24	SP. 07T308	3008-M2.5x6	82-T08
ATUM 23XD5 SP. 07T308	●	23	25	34	193	115	137	56	0.75	24.5			
ATUM 23XD5 SP. 07T308-32	●	23	32	44	202	115	142	60	0.75	24.5			
ATUM 24XD5 SP. 07T308-32	●	24	32	44	207	120	147	60	0.5	25	SP. 090408	4015-M3.5x9	80-T15
ATUM 25XD5 SP. 07T308	●	25	25	34	203	125	147	56	0.25	25.5			
ATUM 25XD5 SP. 07T308-32	●	25	32	44	212	125	152	60	0.25	25.5			
ATUM 26XD5 SP. 07T308	●	26	25	34	208	130	152	56	0	26	SP. 090408	4015-M3.5x9	80-T15
ATUM 26XD5 SP. 07T308-32	●	26	32	44	217	130	157	60	0	26			
ATUM 27XD5 SP. 07T308	●	27	25	34	213	135	157	56	0	27			
ATUM 27XD5 SP. 07T308-32	●	27	32	44	222	135	162	60	0	27	SP. 090408	4015-M3.5x9	80-T15
ATUM 28XD5 SP. 090408-32	●	28	32	44	227	140	167	60	1	30			
ATUM 29XD5 SP. 090408-32	●	29	32	44	232	145	172	60	0.75	30.5			
ATUM 30XD5 SP. 090408	●	30	32	44	237	150	177	60	0.5	31	SP. 090408	4015-M3.5x9	80-T15
ATUM 31XD5 SP. 090408	●	31	32	44	242	155	182	60	0.25	31.5			
ATUM 32XD5 SP. 090408	●	32	32	44	247	160	187	60	0	32			
ATUM 33XD5 SP. 090408	●	33	32	44	252	165	192	60	0	33			

R: Sağ / Right / Rechts/ L: Sol / Left / Links

● Stokta / In Stock / Auf Lager ○ Stokta Yok / Non Stock Item / Kein Lagerartikel, Lieferzeit auf Anfrage  
TGTC Ucuna Uygundur. / Compatible with TGTC Insert. / Kompatibel mit TGTC Wendeplatten.

Sipariş Örneği/Ordering Example/Bestellbeispiel  
1 ad./pcs./stück ATUM 13XD5 SP. 050204

Takma Uçlu Matkap Kullanım Kılavuzu : S 375 / User's Guide For U-Drills : P 375  
Bedienungsanleitung für Vollbohrer : S 375

# HELİSEL İÇTEN SU VERME KANALLI MATKAPLAR

## INDEXABLE DRILLS WITH HELICAL COOLANT HOLE

Farklı çaplarda ve ALFA KAPLAMA teknolojisi ile siparişe hazır.

**They are ready to order in different diameters and with ALPHA COATING technology.**

- Helisel içten su verme kanallı • **Helical Internal Coolant Holes**
- Üstün Alpha Kaplama Teknolojisi • **Superior Alpha Coating Technology**
- 1000 Vickers'e dayanan yüksek yüzey sertliği • **High surface hardness up to 1000 Vickers**
- Aşınmaya karşı yüksek direnç • **High resistance to abrasion**
- Dengeli ve hassas kesim • **Balanced and precise cutting**

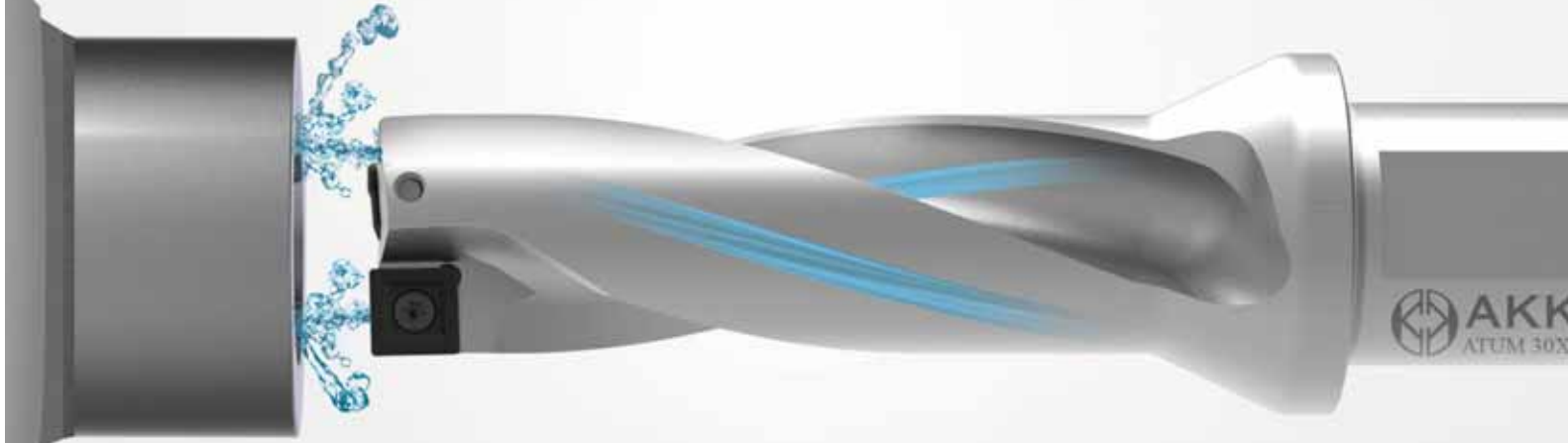

AKKO HELİSEL KANAL TEKNOLOJİSİ  
AKKO HELICAL CHANNEL TECHNOLOGY

RAKİPLER  
COMPETITORS

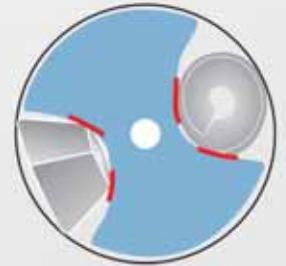

\* STOK DURUMU / STOCK STATUS

**D2 / D3 / D4 / D5**

\* Helisel İçten Su Verme Kanalı  
Twisted Coolant Hole

# KESME & KANAL AÇMA UÇ VE TAKIMLARI

GROOVING & PARTING INSERT AND TOOLS  
EINSTECH- UND ABSTECHWENDESCHIEPLATTEN  
UND WERKZEUGE

AGD-MT / AGD-MR Uç Serisi / Insert Series / Insert Serie



## Kesme ve Kanal Açma Uçlarına Genel Bakış

### Overview of Parting and Grooving Inserts

Überblick über Wendeschneidplatten zum Abstechen und Einstechen

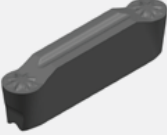
Form Shape	Geometri Geometry	Ugulama Application	Genişlik Width
	AGD-MT	Medium Turning	2.0-8.0 (mm)
	AGD-MR	Medium Profiling	2.0-8.0 (mm)

## Önerilen Kesme Değerleri Recommended Cutting Datas Empfohlene Schnittdaten

### AGD-MT

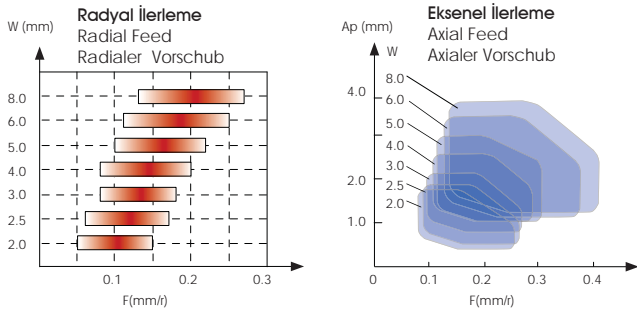

### AGD-MR

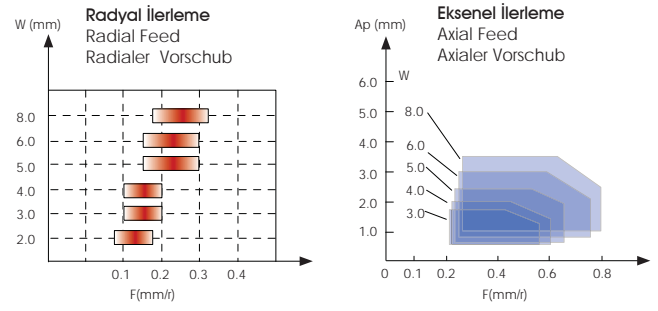

ISO	İs Parçası Malzemesi Workpiece Material	Sertlik Hardness ( HB )	Kesme Hızı / Cutting Speed Vc m/min / Schneidgeschwindigkeit						
			AP1105	AP1225	AK1115	AS3115	AS3125	AA4230	AS9125
P	Düşük Karbonlu Çelik Low Carbon Steel	80 – 170	120 (80-220)	120 (80-220)		70 (50-100)	70 (50-100)	110 (70-180)	
	Yüksek Karbonlu Çelik High Carbon Steel	170 – 250	120 (80-220)	120 (80-220)				110 (70-150)	
	Düşük Alaşımli Çelik Low-alloy Steel	140 – 260	110 (60-180)	110 (60-180)		70 (50-100)	70 (50-100)	(40-150)	
	Yüksek Alaşımli Çelik High-alloy Steel	180 – 300	110 (60-180)	110 (60-180)				110 (40-150)	
	Dökme Çelik Cast Steel	180 – 300	110 (60-180)	110 (60-180)				110 (40-150)	
M	Feritik / Martenzitik Ferritic / Martensitic	150 – 270				90 (50-150)	90 (30-180)	110 (40-180)	
	Östenitik Austenitic	150 – 270				90 (50-150)	90 (30-180)	(40-180)	
K	Dövülebilir Dökme Demir Malleable Cast Iron	150 – 230			130 (50-200)			(50-180)	
	Grı Dökme Demir Gray Cast Iron	150 – 230			130 (50-200)			110 (50-180)	
	Sferö Döküm Demir Nodular Cast Iron	160 – 260			100 (50-150)			100 (50-150)	
S	Isıya Dayanımlı Alaşımlar Heat-resistant Alloy	130 – 400				35 (15-60)	35 (15-70)		
	Titanyum Alaşımlar Titanium Alloys	130 – 400				35 (15-60)	35 (15-70)		35 (15-60)

1	2	3	4-5	6-7	8	9	10
A	G	D	30--04	MT	A	A	4230
AKKO	GROOVING KANAL AÇMA	D DOUBLE SIDE ÇİFT TARAFLI S SINGLE SIDE TEK TARAFLI	WIDTH GENİŞLİK CORNER RADIUS KÖŞE YARIÇAPI	CHIP BREAKER TALAŞ KIRICI FORM MT: MEDIUM TURNING MT: ORTA TORNALAMA MR:MEDIUM PROFILING MR:ORTA PROFİLLEME	AKKO	A: GENERAL / GENEL P: STEEL / ÇELİK K: CAST IRON / DÖKÜM M: STAINLESS STEEL / PASLANMAZ S: HEAT RESISTANT ALLOYS / TITANIUM ISIYA DAYANIKLI ALAŞIMLAR / TİTANYUM N: NON-FERROUS METARIALS DEMİR OLMAYAN METALLER H: HARDENED STEEL / SERT METAL	GRADE / SERTLİK

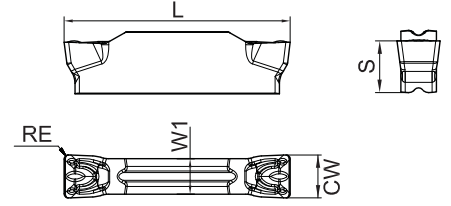

## AGD-MT

AKKO Çift Taraflı Kesme Uçları  
AKKO Grooving Double Side  
AKKO Nuten beidseitig



Sipariş Kodu Ordering Code Bestellungsnummer	Ölçü / Dimension (mm) / Dimension					Kalite / Grade / Qualität		
	CW±0.05	RE±0.05	L	W1	S	AP1225	AK1115	AA4230
AGD2002-MT	2.0	0.2	16.0	1.2	3.5	●	●	●
AGD2502-MT	2.5	0.2	18.5	2.0	3.85	●	●	●
AGD3004-MT	3.0	0.4	21.2	2.35	4.8	●	●	●
AGD4004-MT	4.0	0.4	21.0	3.3	4.8	●	●	●
AGD5004-MT	5.0	0.4	26.0	4.1	5.8	●	●	●
AGD5008-MT	5.0	0.8	26.0	4.1	5.8	●	●	●
AGD6004-MT	6.0	0.4	26.0	5.0	5.8	●	●	●
AGD6008-MT	6.0	0.8	26.0	5.0	5.8	●	●	●
AGD8008-MT	8.0	0.8	31.0	6.0	6.5	●	●	●

● Stok ○ Talep Edilmesi Halinde Üretilecek  
Stock Available upon order

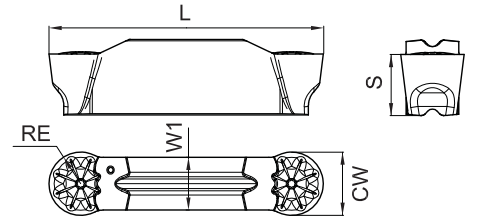

## AGD-MR

AKKO Çift Taraflı Kesme Uçları  
AKKO Grooving Double Side  
AKKO Nuten beidseitig



Sipariş Kodu Ordering Code Bestellungsnummer	Ölçü / Dimension (mm) / Dimension					Kalite / Grade / Qualität			
	CW±0.05	RE±0.05	L	W1	S	AP1105	AP1225	AK1115	AA4230
AGD2010-MR	2.0	1.0	16.0	1.2	3.5	●	●	●	●
AGD3015-MR	3.0	1.5	21.2	2.35	4.8	●	●	●	●
AGD4020-MR	4.0	2.0	21.0	3.3	4.8	●	●	●	●
AGD5025-MR	5.0	2.5	26.0	4.1	5.8	●	●	●	●
AGD6030-MR	6.0	3.0	26.0	5.0	5.8	●	●	●	●
AGD8040-MR	8.0	4.0	31.0	6.0	6.5	●	●	●	●

● Stok ○ Talep Edilmesi Halinde Üretilecek  
Stock Available upon order

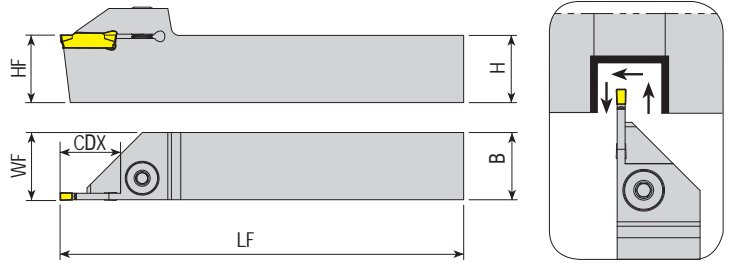

Takım Kodu Ordering Code Bestell-Bezeichnung	Stok Stock		Takım Ölçüleri (mm) Dimension (mm)				Kesici Uç Insert	Yedek Parçaları / Spare Parts			
	R	L	HF=H	B	LF	WF		CDX	Sıkma Vidası Screw	Pul Stamp	Anahtar Allen Key
ADKT-K-R/L-1212-1.5-T15	●	●	12	12	100	12.2	15	MGM. - 1.5	AKV-02-M6x22	ABPL-01	AAL-03-3
ADKT-K-R/L-2020-1.5-T15	●	●	20	20	125	20.2	15				
ADKT-K-R/L-1212-2-T15	●	●	12	12	100	16.3	15	AGD. - 2 MGM. - 2	AKV-02-M6x22	ABPL-01	AAL-03-3
ADKT-K-R/L-1616-2-T10	●	●	16	16	125	16.3	10				
ADKT-K-R/L-1616-2-T15	●	●	16	16	125	16.3	15	AGD. - 3 MGM. - 3	AKV-02-M6x22	ABPL-01	AAL-03-3
ADKT-K-R/L-2020-2-T15	●	●	20	20	150	20.3	15				
ADKT-K-R/L-2525-2-T15	●	●	25	25	150	25.3	15	AGD. - 4 MGM. - 4	2004-M8x1x20	-	AAL-05-4
ADKT-K-R/L-3232-2-T15	●	●	32	32	170	32.3	15				
ADKT-K-R/L-1212-3-T15	●	●	12	12	100	12.3	15	AGD. - 5 MGM. - 5	2004-M8x1x20	-	AAL-05-4
ADKT-K-R/L-1616-3-T15	●	●	16	16	125	16.3	15				
ADKT-K-R/L-2020-3-T10	●	●	20	20	125	20.3	10	AGD. - 6 MGM. - 6	2004-M8x1x20	-	AAL-05-4
ADKT-K-R/L-2020-3-T20	●	●	20	20	125	20.3	20				
ADKT-K-R/L-2020-3-R28	●	●	20	20	125	20.3	28	AGD. - 8 / MGM. - 8	2004-M8x1x20	-	AAL-05-4
ADKT-K-R/L-2525-3-T10	●	●	25	25	150	25.3	10				
ADKT-K-R/L-2525-3-R15	●	●	25	25	150	25.3	15	AGD. - 5 MGM. - 5	2004-M8x1x20	-	AAL-05-4
ADKT-K-R/L-2525-3-T22	●	●	25	25	150	25.3	22				
ADKT-K-R/L-3232-3-T10	●	●	32	32	170	32.3	10	AGD. - 6 MGM. - 6	2004-M8x1x20	-	AAL-05-4
ADKT-K-R/L-3232-3-T22	●	●	32	32	170	32.3	22				
ADKT-K-R/L-2020-4-T10	●	●	20	20	125	20.4	10	AGD. - 4 MGM. - 4	2004-M8x1x20	-	AAL-05-4
ADKT-K-R/L-2020-4-T20	●	●	20	20	125	20.4	20				
ADKT-K-R/L-2020-4-R25	●	○	20	20	125	20.4	25	AGD. - 5 MGM. - 5	2004-M8x1x20	-	AAL-05-4
ADKT-K-R/L-2525-4-T10	●	●	25	25	150	25.4	10				
ADKT-K-R/L-2525-4-T18	●	●	25	25	150	25.4	18	AGD. - 6 MGM. - 6	2004-M8x1x20	-	AAL-05-4
ADKT-K-R/L-2525-4-T22	●	●	25	25	150	25.4	22				
ADKT-K-R/L-3232-4-T10	●	●	32	32	170	32.4	10	AGD. - 8 / MGM. - 8	2004-M8x1x20	-	AAL-05-4
ADKT-K-R/L-3232-4-T22	●	●	32	32	170	32.4	22				
ADKT-K-R/L-2020-5-T20	●	●	20	20	125	20.5	20	AGD. - 5 MGM. - 5	2004-M8x1x20	-	AAL-05-4
ADKT-K-R/L-2525-5-T15	●	●	25	25	150	25.5	15				
ADKT-K-R/L-2525-5-T18	●	●	25	25	150	25.5	18	AGD. - 6 MGM. - 6	2004-M8x1x20	-	AAL-05-4
ADKT-K-R/L-2525-5-T25	●	●	25	25	150	25.5	25				
ADKT-K-R/L-3232-5-T15	●	●	32	32	170	32.5	15	AGD. - 8 / MGM. - 8	2004-M8x1x20	-	AAL-05-4
ADKT-K-R/L-3232-5-T25	●	●	32	32	170	32.5	25				
ADKT-K-R/L-2525-6-T15	●	●	25	25	150	25.6	15	AGD. - 6 MGM. - 6	2004-M8x1x20	-	AAL-05-4
ADKT-K-R/L-2525-6-T25	●	●	25	25	150	25.6	25				
ADKT-K-R/L-3232-6-T25	●	●	32	32	170	32.6	25	AGD. - 8 / MGM. - 8	2004-M8x1x20	-	AAL-05-4
ADKT-K-R/L-3232-8-T32	●	●	32	32	170	32.8	32				

R: Sağ / Right L: Sol / Left

● Stokta / In Stock ○ Stokta Yok / Non Stock Item

Sipariş Örneği/Ordering Example/Bestellbeispiel  
1 ad./pcs. /stück ADKT-K-R-1212-1.5-T15

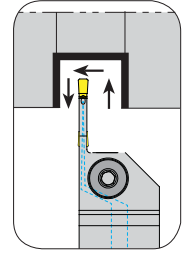
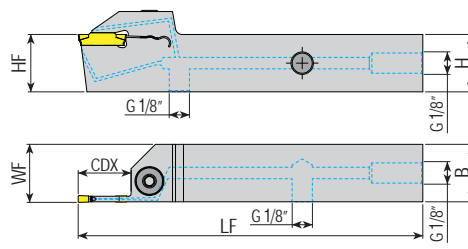

Takım Kodu Ordering Code Bestell-Bezeichnung	Stok Stock		Takım Ölçüleri (mm) Dimension (mm)					Kesici Uç Insert	Yedek Parçaları / Spare Parts		
	R	L	HF=H	B	LF	WF	CDX		Sıkma Vidası Screw	Pul Stamp	Anahtar Allen Key
ADKT-K-R/L-2020-3-T20-H	●	●	20	20	125	20.4	20	AGD. - 3 MGM. - 3	2004-M8x1x20	-	AAL-05-4
ADKT-K-R/L-2525-3-T22-H	●	●	25	25	150	25.4	22				
ADKT-K-R/L-2020-4-T20-H	●	●	20	20	125	20.4	20	AGD. - 4 MGM. - 4			
ADKT-K-R/L-2525-4-T22-H	●	●	25	25	150	25.4	22				
ADKT-K-R/L-2525-5-T25-H	●	●	25	25	150	25.5	25	AGD. - 5 / MGM. - 5			

DIŞ ÇAP KANAL AÇMA İSVİÇRE TİPİ KAYAR OTOMAT MAKİNA TAKIMLARI  
EXTERNAL GROOVING TOOLHOLDERS FOR SWISS TYPE SLIDING AUTOMATIC LATHES  
WERKZEUGE ZUR STECHBEARBEITUNG AUF LANGDREHAUTOMATEN

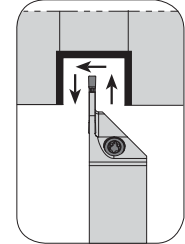
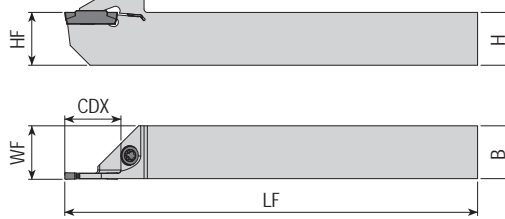

Takım Kodu Ordering Code Bestell-Bezeichnung	Stok Stock		Takım Ölçüleri (mm) Dimension (mm)					Kesici Uç Insert	Yedek Parçaları / Spare Parts		
	R	L	HF=H	B	LF	WF	CDX		Sıkma Vidası Screw	Pul Stamp	Anahtar Allen Key
ADKT-K-R/L-1212-2-R12-K-S	●	●	12	12	125	12.20	12	AGD. - 2 MGM. - 2	4015-M4x11	-	80-T15
ADKT-K-R/L-1616-2-R16-K-S	●	●	16	16	125	16.20	16				
ADKT-K-R/L-1212-3-R12-K-S	●	●	12	12	125	12.30	12	AGD. - 3 MGM. - 3			
ADKT-K-R/L-1616-3-R16-K-S	●	●	16	16	125	16.30	16				

Sipariş Örneği/Ordering Example/Bestellbeispiel  
1 ad./pcs./stück ADKT-K-R/L-2020-3-T20-H



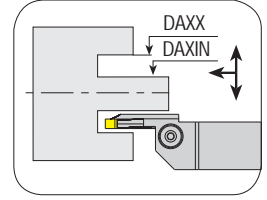
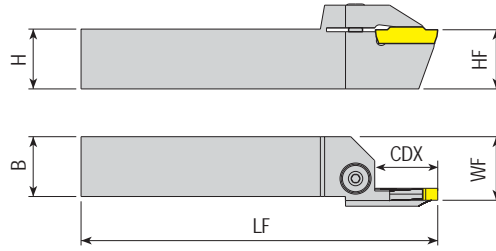

Takım Kodu Ordering Code Bestell-Bezeichnung	Stok Stock		Takım Ölçüleri (mm) Dimension (mm)							Kesici Uç Insert	Yedek Parçaları / Spare Parts		
	R	L	HF=H	B	LF	WF	CDX	DAXIN	DAXX		Sıkma Vidası Screw	Pul Stamp	Anahtar Allen Key
AAKT-K-R/L-2525-34-45-3-T17	●	●	25	25	150	26.5	17	34	45	AGD. - 3 MGM. - 3			
AAKT-K-R/L-2525-39-55-3-T17	●	●	25	25	150	26.5	17	39	55				
AAKT-K-R/L-2525-49-80-3-T17	●	●	25	25	150	26.5	17	49	80				
AAKT-K-R/L-2525-70-110-3-T17	●	●	25	25	150	26.5	17	70	110				
AAKT-K-R/L-2525-100-150-3-T17	●	●	25	25	150	26.5	17	100	150				
AAKT-K-R/L-2525-80-180-3-T32	●	●	25	25	150	26.5	32	80	180				
AAKT-K-R/L-2525-175-215-3-T22	●	●	25	25	150	26.5	22	175	215				
AAKT-K-R/L-2525-700-800-3-T17	●	●	25	25	150	26.5	17	700	800				
AAKT-K-R/L-2525-50-85-4-T22	●	●	25	25	150	26.5	22	50	85	AGD. - 4 MGM. - 4	2004-M8x1x20	-	AAL-05-4
AAKT-K-R/L-2525-70-110-4-T22	●	●	25	25	150	26.5	22	70	110				
AAKT-K-R/L-2525-100-150-4-T22	●	●	25	25	150	26.5	22	100	150				
AAKT-K-R/L-2525-80-180-4-T32	●	●	25	25	150	26.5	32	80	180				
AAKT-K-R/L-2525-180-800-4-T32	●	●	25	25	150	26.5	32	180	800				
AAKT-K-R/L-2525-70-110-5-T25	●	●	25	25	150	26.5	25	70	110	AGD. - 5 MGM. - 5			
AAKT-K-R/L-2525-100-150-5-T25	●	●	25	25	150	26.5	25	100	150				
AAKT-K-R/L-2525-80-180-5-T32	●	●	25	25	150	26.5	32	80	180				
AAKT-K-R/L-2525-140-200-5-T25	●	●	25	25	150	26.5	25	140	200				
AAKT-K-R/L-2525-180-800-5-T32	●	●	25	25	150	26.5	32	180	800				
AAKT-K-R/L-2525-60-100-6-T25	●	●	25	25	150	26.5	25	60	100	AGD. - 6 MGM. - 6			
AAKT-K-R/L-2525-60-100-6-T35	●	○	25	25	150	26.5	35	60	100				
AAKT-K-R/L-2525-100-200-6-T25	●	○	25	25	150	26.5	25	100	200				
AAKT-K-R/L-2525-100-200-6-T35	●	○	25	25	150	26.5	35	100	200				
AAKT-K-R/L-2525-100-200-6-T45	●	○	25	25	150	26.5	45	100	200				
AAKT-K-R/L-2525-140-300-6-T35	●	●	25	25	150	26.5	35	140	300				
AAKT-K-R/L-2525-140-300-8-T35	●	○	25	25	150	26.5	35	140	300	AGD. - 8 MGM. - 8			
AAKT-K-R/L-3232-140-350-8-T35	●	○	32	32	150	33.5	35	140	350				

R: Sağ / Right L: Sol / Left

● Stokta / In Stock ○ Stokta Yok / Non Stock Item

Sipariş Örneği/Ordering Example/Bestellbeispiel  
1 ad./pcs./stück AAKT-K-R-2525-34-45-3-T17

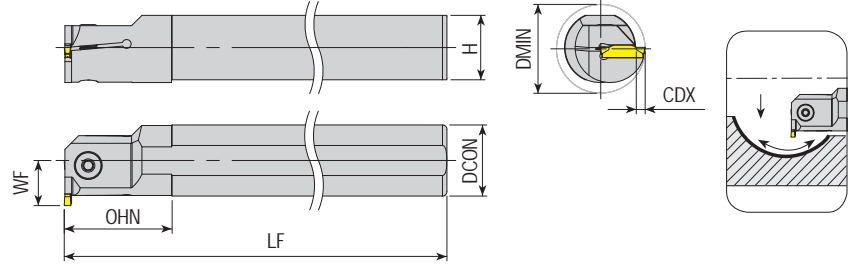

Takım Kodu Ordering Code Bestell-Bezeichnung	Stok Stock		Takım Ölçüleri (mm) Dimension (mm)							Kesici Uç Insert	Yedek Parçaları / Spare Parts	
	R	L	DCON	DMIN	LF	OHN	CDX	H	WF		Sıkma Vidası Screw	Anahtar Allen Key
AIKT-K-R/L-16-2-T4	●	●	16	21	150	28	4	14.8	12	AGD. - 2 MGM. - 2	2503-M4x10	AAL-03-3
AIKT-K-R/L-20-2-T4	●	●	20	25	170	30	4	18.3	14		2503-M4x12	
AIKT-K-R/L-25-2-T6	●	●	25	32	200	40	6	23	18.5		2504-M5x12	
AIKT-K-R/L-20-3-T6	●	●	20	27	170	30	6	18.3	16	AGD. - 3 MGM. - 3	2504-M5x12	AAL-05-4
AIKT-K-R/L-20-3-T7	●	●	20	25	170	38	7	18.3	13		2504-M5x16	
AIKT-K-R/L-25-3-T6	●	●	25	32	200	40	6	23	18.5		2504-M5x16	
AIKT-K-R/L-25-3-T10	●	●	25	32	200	48	10	23	17		2004-M8x1x20	
AIKT-K-R/L-32-3-T6	●	●	32	39	250	50	6	30	22		2004-M8x1x20	
AIKT-K-R/L-32-3-T12	●	●	32	39	250	53	12	30	22		2004-M8x1x20	
AIKT-K-R/L-40-3-T6	●	●	40	47	300	55	6	37.5	26		2004-M8x1x20	
AIKT-K-R/L-40-3-T12	●	○	40	48	300	63	12	37.5	27		2004-M8x1x20	
AIKT-K-R/L-20-4-T6	●	●	20	27	170	30	6	18.3	16		2504-M5x12	
AIKT-K-R/L-20-4-T7	●	○	20	25	170	38	7	18.3	13		2504-M5x16	
AIKT-K-R/L-25-4-T6	●	●	25	32	200	40	6	23	18.5	2504-M5x16		
AIKT-K-R/L-25-4-T10	●	●	25	32	200	49	10	23	17	2004-M8x1x20		
AIKT-K-R/L-32-4-T6	●	●	32	39	250	50	6	30	22	2004-M8x1x20		
AIKT-K-R/L-32-4-T12	●	●	32	39	250	53	12	30	22	2004-M8x1x20		
AIKT-K-R/L-40-4-T6	●	●	40	47	300	55	6	37.5	26	2004-M8x1x20		
AIKT-K-R/L-40-4-T12	●	●	40	48	300	63	12	37.5	27	2004-M8x1x20		
AIKT-K-R/L-25-5-T7	●	●	25	33	200	40	7	23	19.5	2504-M5x16		
AIKT-K-R/L-32-5-T7	●	●	32	40	250	50	7	30	23	2004-M8x1x20		
AIKT-K-R/L-40-5-T7	●	●	40	48	300	55	7	37.5	27	2004-M8x1x20		
AIKT-K-R/L-40-5-T12	●	○	40	48	300	63	12	37.5	27	2004-M8x1x20		

R: Sağ / Right L: Sol / Left  
● Stokta / In Stock ○ Stokta Yok / Non Stock Item

Sipariş Örneği/Ordering Example/Bestellbeispiel  
1 ad./pcs./stück. AIKT-K-R-16-2-T4

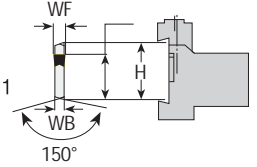
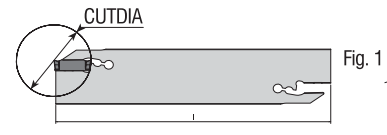
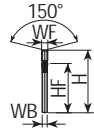
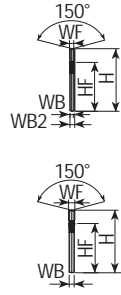

Takım Kodu Ordering Code Bestell-Bezeichnung	Stok Stock	Takım Ölçüleri (mm) Dimension (mm)							Kesici Uç Insert	Yedek Parçaları / Spare Parts	
		H	WF	WB2	WB	I	HF	CUTDIA		Anahtar Allen Key	
AKL-K-32-2	●	32	2	2.4	1.6	150	25	32	AGD. - 2 / MGM. - 2	ALA-02	
AKL-K-32-3	●	32	3	2.4	-	150	25	42	AGD. - 3 / MGM. - 3		
AKL-K-32-4	●	32	4	3.2	-	150	25	42	AGD. - 4 / MGM. - 4		



# BARALAR

AYARLI DELİK İŞLEME BARALARI  
ADJUSTABLE BORING HEADS  
EINSTELLBARE SPINDELKÖPFE



AKKO **A** **BH** **R** - **D18x22**

**W16** - **L90** - **CC06**

**2** Kesiş Stili / Cutter Style / Werkzeugtyp

BH : Delik İşleme / Boring Head  
Spindelkopf

**3** İşlem Tipi / Cutter Type / Einsatzgebiet

R : Kaba Baralama / Rough Boring  
Schruppbearbeitung  
F : Hassas Baralama / Fine Boring  
Schlichtbearbeitung

**5** Montaj Formu / Assembly Form / Schaftform

W : Weldon

**4** Ölçü Aralığı / Boring Range / Bohrbereich

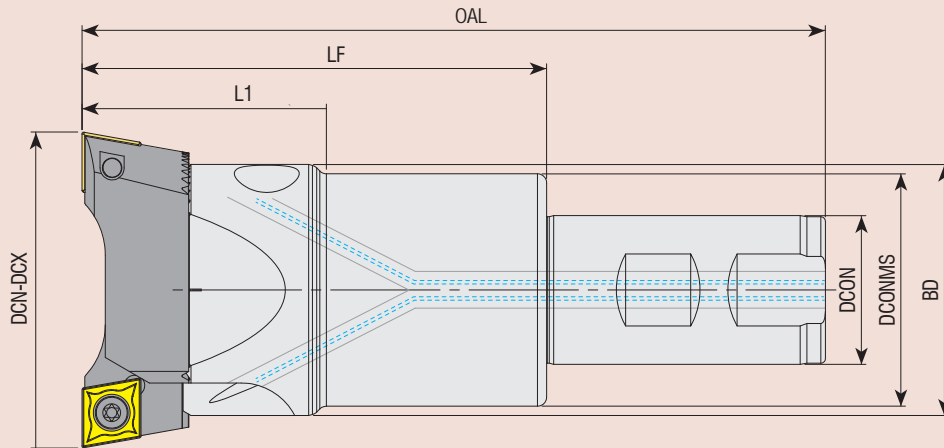

**6** Takım Boyu / Tool Length / Werkzeuglänge

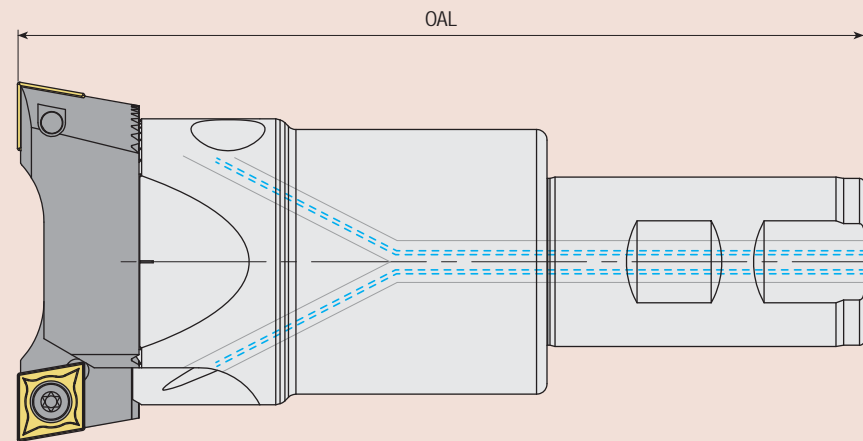

**7** Kesici Uç / Insert / Wendschneidplatte

CC06 : CC.. 0602..  
CC09 : CC.. 09T3..  
CC12 : CC.. 1204..



EDP	DESCRIPTION / AÇIKLAMA	CUTTING SPEED Vc=m/min KESME HIZI	FEED fn=mm/rev İLERLEME
T.01.08.03.01	CCGT 09T302L-AC1020	100-200	0.15~0.3
T.01.08.03.02	CCGT 09T304L-AC1020	100-200	0.2~0.4



EDP	DESCRIPTION / AÇIKLAMA	CUTTING SPEED Vc=m/min KESME HIZI	FEED fn=mm/rev İLERLEME
T.01.08.03.01	TPGH 09T0202L-AC1020	100-200	0.15~0.3
T.01.08.03.02	TPGH 09T0204L-AC1020	100-200	0.2~0.4

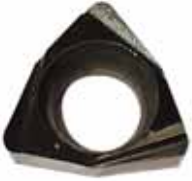

EDP	DESCRIPTION / AÇIKLAMA	CUTTING SPEED Vc=m/min KESME HIZI	FEED fn=mm/rev İLERLEME
T.01.08.03.01	WCGT 020102L-AC1020	100-200	0.05~0.2
T.01.08.03.02	WCGT 020104L-AC1020	100-200	0.08~0.3





*konusulan  
the spoken kalite...  
quality...*

[www.akkocom.tr](http://www.akkocom.tr)



